

Test Report

No.: SHAEC25018974601

Date: Aug 01, 2025

Page 1 of 21

Client Name: Advanced Semiconductor Manufacturing Co., Ltd
 Client Address: 385 Hongcao Road, Xuhui Dirstrict, Shanghai, China

Sample Name: Wafer

The above sample(s) and information were provided by the client.

SGS Job No.: SHP25-025390
 Sample Receiving Date: Jul 28, 2025
 Testing Period: Jul 28, 2025 ~ Aug 01, 2025
 Test Requested: Select test(s) as requested by the client.
 Test Method(s): Please refer to next page(s).
 Test Result(s): Please refer to next page(s).

Test Requirement	Conclusion
EU RoHS Directive (EU) 2015/863 amending Annex II to Directive 2011/65/EU - Lead, Mercury, Cadmium, Hexavalent chromium, Polybrominated biphenyls (PBB), Polybrominated diphenyl ethers (PBDE), Bis(2-ethylhexyl) phthalate (DEHP), Butyl benzyl phthalate (BBP), Dibutyl phthalate (DBP) and Diisobutyl phthalate (DIBP)	Pass
Tetrabromobisphenol A (TBBP-A)	See Results
Alkanes C14-C17, chloro (medium- chain chlorinated paraffins) (MCCPs)	See Results
Element(s)	See Results
Halogen	See Results
Hexabromocyclododecane (HBCDD)	See Results
Polychlorinated Biphenyls (PCBs)	See Results
Polyvinyl chloride (PVC)	See Results
PFOS, its salts and related compounds,PFOA, its salts	See Results

Signed for and on behalf of
 SGS-CSTC Standards Technical Services (Shanghai) Co., Ltd.

Sue Sheng
 Approved Signatory

Scan to see the report



DFAB4FF8



Unless otherwise agreed in writing, this document is issued by the Company subject to its General Conditions of Service printed overleaf, available on request or accessible at <https://www.sgs.com/en/Terms-and-Conditions>. Attention is drawn to the limitation of liability, indemnification and jurisdiction issues defined therein. Any holder of this document is advised that information contained hereon reflects the Company's findings at the time of its intervention only and within the limits of Client's instructions, if any. The Company's sole responsibility is to its Client and this document does not exonerate parties to a transaction from exercising all their rights and obligations under the transaction documents. This document cannot be reproduced except in full, without prior written approval of the Company. Any unauthorized alteration, forgery or falsification of the content or appearance of this document is unlawful and offenders may be prosecuted to the fullest extent of the law. Unless otherwise stated the results shown in this test report refer only to the sample(s) tested.

Attention: To check the authenticity of testing /inspection report & certificate, please contact us at telephone: (86-755) 8307 1443, or email: CN.Doccheck@sgs.com

SGS-CSTC Standards Technical Services (Shanghai) Co., Ltd.
 Chemical Laboratory

3rd Building, No.889 Yishan Road Xuhui District, Shanghai China 200233 t E&E (86-21) 61402553 f E&E (86-21) 64953679 www.sgsgroup.com.cn
 中国·上海·徐汇区宜山路889号3号楼 邮编: 200233 t HL (86-21) 61402594 f HL (86-21) 61156899 sgs.china@sgs.com

Test Report

No.: SHAEC25018974601

Date: Aug 01, 2025

Page 2 of 21

Test Requirement	Conclusion
Phthalates	See Results
Red Phosphorus	See Results

Test Result(s):

Test Part Description:

SN ID	Sample No.	SGS Sample ID	Description
SN1	A1	SHA25-0189746-0001.C001	Colorful wafer

Remarks:

- (1) 1 mg/kg = 1 ppm = 0.0001%
- (2) MDL = Method Detection Limit
- (3) ND = Not Detected (< MDL)
- (4) "-" = Not Regulated

EU RoHS Directive (EU) 2015/863 amending Annex II to Directive 2011/65/EU - Lead, Mercury, Cadmium, Hexavalent chromium, Polybrominated biphenyls (PBB), Polybrominated diphenyl ethers (PBDE), Bis(2-ethylhexyl) phthalate (DEHP), Butyl benzyl phthalate (BBP), Dibutyl phthalate (DBP) and Diisobutyl phthalate (DIBP)

Test Method: With reference to IEC 62321-4:2013+AMD1:2017, IEC 62321-5:2013, IEC 62321-7-2:2017 and IEC 62321-12:2023, analysis was performed by ICP-OES/AAS, UV-Vis and GC-MS.

Test Item(s)	Limit	Unit(s)	MDL	A1
Lead (Pb)	1000	mg/kg	2	ND
Mercury (Hg)	1000	mg/kg	2	ND
Cadmium (Cd)	100	mg/kg	2	ND
Hexavalent Chromium (Cr(VI))	1000	mg/kg	8	ND
Polybrominated biphenyls (PBB)	1000	mg/kg	-	ND
Monobrominated biphenyl (MonoBB)	-	mg/kg	25	ND
Dibrominated biphenyl (DiBB)	-	mg/kg	25	ND
Tribrominated biphenyl (TriBB)	-	mg/kg	25	ND
Tetrabrominated biphenyl (TetraBB)	-	mg/kg	25	ND
Pentabrominated biphenyl (PentaBB)	-	mg/kg	25	ND
Hexabrominated biphenyl (HexaBB)	-	mg/kg	25	ND
Heptabrominated biphenyl (HeptaBB)	-	mg/kg	25	ND
Octabrominated biphenyl (OctaBB)	-	mg/kg	25	ND
Nonabrominated biphenyl (NonaBB)	-	mg/kg	25	ND
Decabrominated biphenyl (DecaBB)	-	mg/kg	25	ND
Polybrominated diphenyl ethers (PBDE)	1000	mg/kg	-	ND
Monobrominated diphenyl ether (MonoBDE)	-	mg/kg	25	ND
Dibrominated diphenyl ether (DiBDE)	-	mg/kg	25	ND
Tribrominated diphenyl ether (TriBDE)	-	mg/kg	25	ND
Tetrabrominated diphenyl ether (TetraBDE)	-	mg/kg	25	ND
Pentabrominated diphenyl ether (PentaBDE)	-	mg/kg	25	ND



Unless otherwise agreed in writing, this document is issued by the Company subject to its General Conditions of Service printed overleaf, available on request or accessible at <https://www.sgs.com/en/Terms-and-Conditions>. Attention is drawn to the limitation of liability, indemnification and jurisdiction issues defined therein. Any holder of this document is advised that information contained hereon reflects the Company's findings at the time of its intervention only and within the limits of Client's instructions, if any. The Company's sole responsibility is to its Client and this document does not exonerate parties to a transaction from exercising all their rights and obligations under the transaction documents. This document cannot be reproduced except in full, without prior written approval of the Company. Any unauthorized alteration, forgery or falsification of the content or appearance of this document is unlawful and offenders may be prosecuted to the fullest extent of the law. Unless otherwise stated the results shown in this test report refer only to the sample(s) tested.

Attention: To check the authenticity of testing /inspection report & certificate, please contact us at telephone: (86-755) 8307 1443, or email: CN.Doccheck@sgs.com

SGS-CSI (Shanghai) Technical Services (Shanghai) Co., Ltd.
Chemical Laboratories

3rd Building, No. 889 Yishan Road Xuhui District, Shanghai China 200233 t E&E (86-21) 61402553 f E&E (86-21) 64953679 www.sgsgroup.com.cn
中国·上海·徐汇区宜山路889号3号楼 邮编: 200233 t HL (86-21) 61402594 f HL (86-21) 61156899 sgs.china@sgs.com

Test Report

No.: SHAEC25018974601

Date: Aug 01, 2025

Page 3 of 21

Test Item(s)	Limit	Unit(s)	MDL	A1
Hexabrominated diphenyl ether (HexaBDE)	-	mg/kg	25	ND
Heptabrominated diphenyl ether (HeptaBDE)	-	mg/kg	25	ND
Octabrominated diphenyl ether (OctaBDE)	-	mg/kg	25	ND
Nonabrominated diphenyl ether (NonaBDE)	-	mg/kg	25	ND
Decabrominated diphenyl ether (DecaBDE)	-	mg/kg	25	ND
Bis(2-ethylhexyl) phthalate (DEHP)	1000	mg/kg	50	ND
Butyl benzyl phthalate (BBP)	1000	mg/kg	50	ND
Dibutyl Phthalate (DBP)	1000	mg/kg	50	ND
Diisobutyl Phthalate (DIBP)	1000	mg/kg	50	ND

Notes:

- (1) The maximum permissible limit is quoted from RoHS Directive (EU) 2015/863.
- (2) IEC 62321 series is equivalent to EN 62321 series.
- (3) The restriction of DEHP, BBP, DBP and DIBP shall apply to medical devices, including in vitro medical devices, and monitoring and control instruments, including industrial monitoring and control instruments, from 22 July 2021.

Tetrabromobisphenol A (TBBP-A)

Test Method: With reference to SGS in house method, analysis was performed by GC-MS or LC-MS.

Test Item(s)	CAS No.	Unit(s)	MDL	A1
Tetrabromobisphenol A (TBBP-A)	79-94-7	mg/kg	5	ND

Alkanes C14-C17, chloro (medium- chain chlorinated paraffins) (MCCPs)

Test Method: With reference to ISO 22818:2021, analysis was performed by GC-NCI-MS.

Test Item(s)	CAS No.	Unit(s)	MDL	A1
Alkanes C ₁₄ -C ₁₇ , chloro (medium- chain chlorinated paraffins) (MCCPs)	85535-85-9 and others	mg/kg	50	ND

Element(s)

Test Method: With reference to US EPA 3052:1996, analysis was performed by ICP-OES/AAS.

Test Item(s)	Unit(s)	MDL	A1
Arsenic(As)	mg/kg	10	ND
Beryllium(Be)	mg/kg	5	ND
Antimony(Sb)	mg/kg	10	ND
Antimony Trioxide(Sb ₂ O ₃) ◆	mg/kg	12	ND

Notes:



Unless otherwise agreed in writing, this document is issued by the Company subject to its General Conditions of Service printed overleaf, available on request or accessible at <https://www.sgs.com/en/Terms-and-Conditions>. Attention is drawn to the limitation of liability, indemnification and jurisdiction issues defined therein. Any holder of this document is advised that information contained hereon reflects the Company's findings at the time of its intervention only and within the limits of Client's instructions, if any. The Company's sole responsibility is to its Client and this document does not exonerate parties to a transaction from exercising all their rights and obligations under the transaction documents. This document cannot be reproduced except in full, without prior written approval of the Company. Any unauthorized alteration, forgery or falsification of the content or appearance of this document is unlawful and offenders may be prosecuted to the fullest extent of the law. Unless otherwise stated the results shown in this test report refer only to the sample(s) tested.
Attention: To check the authenticity of testing /inspection report & certificate, please contact us at telephone: (86-755) 8307 1443, or email: CN.Doccheck@sgs.com
 3rd Building, No. 889 Yishan Road Xuhui District, Shanghai China 200233 t E&E (86-21) 61402553 f E&E (86-21) 64953679 www.sgsgroup.com.cn
 中国·上海·徐汇区宜山路889号3号楼 邮编: 200233 t HL (86-21) 61402594 f HL (86-21) 61156899 sgs.china@sgs.com

Test Report

No.: SHAEC25018974601

Date: Aug 01, 2025

Page 4 of 21

(1) ◆Sb₂O₃ : Calculate from Antimony content.

Halogen

Test Method: With reference to EN 14582:2016, analysis was performed by IC.

Test Item(s)	Unit(s)	MDL	A1
Fluorine(F)	mg/kg	20	ND
Chlorine(Cl)	mg/kg	50	ND
Bromine(Br)	mg/kg	50	ND
Iodine(I)	mg/kg	50	ND

Hexabromocyclododecane (HBCDD)

Test Method: With reference to IEC 62321-9:2021, analysis was performed by GC-MS.

Test Item(s)	CAS No.	Unit(s)	MDL	A1
Hexabromocyclododecane (HBCDD)	134237-50-6 /134237-51-7 /134237-52-8 /25637-99-4 /3194-55-6	mg/kg	20	ND

Polychlorinated Biphenyls (PCBs)

Test Method: With reference to US EPA 8082A:2007, analysis was performed by GC-MS.

Test Item(s)	CAS No.	Unit(s)	MDL	A1
2,2',5-Trichlorobiphenyl (PCB18)	37680-65-2	mg/kg	0.5	ND
2,4,4'-Trichlorobiphenyl (PCB28)	7012-37-5	mg/kg	0.5	ND
2,4',5-Trichlorobiphenyl (PCB31)	16606-02-3	mg/kg	0.5	ND
2,2',3,5'-Tetrachlorobiphenyl (PCB44)	41464-39-5	mg/kg	0.5	ND
2,2',5,5'-Tetrachlorobiphenyl (PCB52)	35693-99-3	mg/kg	0.5	ND
2,2',4,5,5'-Pentachlorobiphenyl (PCB101)	37680-73-2	mg/kg	0.5	ND
2,3',4,4',5-Pentachlorobiphenyl (PCB118)	31508-00-6	mg/kg	0.5	ND
2,2',3,4,4',5'-Hexachlorobiphenyl (PCB138)	35065-28-2	mg/kg	0.5	ND
2,2',4,4',5,5'-Hexachlorobiphenyl (PCB153)	35065-27-1	mg/kg	0.5	ND
2,2',3,4,4',5,5'-Heptachlorobiphenyl (PCB180)	35065-29-3	mg/kg	0.5	ND
2,2',3,3',4,4',5,5',6-Nonachlorobiphenyl (PCB206)	40186-72-9	mg/kg	0.5	ND
4-Chlorobiphenyl (PCB3)	2051-62-9	mg/kg	0.5	ND
2,4'- Dichlorobiphenyl (PCB8)	34883-43-7	mg/kg	0.5	ND
2,4,5-Trichlorobiphenyl (PCB29)	15862-07-4	mg/kg	0.5	ND
2,2',4,6-Tetrachlorobiphenyl (PCB50)	62796-65-0	mg/kg	0.5	ND



Unless otherwise agreed in writing, this document is issued by the Company subject to its General Conditions of Service printed overleaf, available on request or accessible at <https://www.sgs.com/en/Terms-and-Conditions>. Attention is drawn to the limitation of liability, indemnification and jurisdiction issues defined therein. Any holder of this document is advised that information contained hereon reflects the Company's findings at the time of its intervention only and within the limits of Client's instructions, if any. The Company's sole responsibility is to its Client and this document does not exonerate parties to a transaction from exercising all their rights and obligations under the transaction documents. This document cannot be reproduced except in full, without prior written approval of the Company. Any unauthorized alteration, forgery or falsification of the content or appearance of this document is unlawful and offenders may be prosecuted to the fullest extent of the law. Unless otherwise stated the results shown in this test report refer only to the sample(s) tested.

Attention: To check the authenticity of testing /inspection report & certificate, please contact us at telephone: (86-755) 8307 1443, or email: CN.Doccheck@sgs.com

SGS-CSI (Shanghai) Technical Services (Shanghai) Co., Ltd.
Chemical Laboratories

3rd Building, No. 889 Yishan Road Xuhui District, Shanghai China 200233
中国·上海·徐汇区宜山路889号3号楼 邮编: 200233

t E&E (86-21) 61402553 f E&E (86-21) 64953679 www.sgsgroup.com.cn
t HL (86-21) 61402594 f HL (86-21) 61156899 sgs.china@sgs.com

Test Report

No.: SHAEC25018974601

Date: Aug 01, 2025

Page 5 of 21

Test Item(s)	CAS No.	Unit(s)	MDL	A1
2,2',3,4',5',6'-Hexachlorobiphenyl (PCB149)	38380-04-0	mg/kg	0.5	ND
2,2',3,3',4,4',5,5'- Octachlorobiphenyl (PCB194)	35694-08-7	mg/kg	0.5	ND
2,2',3,3',4,4',5,5',6,6'-Decachlorobiphenyl (PCB209)	2051-24-3	mg/kg	0.5	ND

Polyvinyl chloride (PVC)

Test Method: With reference to SGS in house method, analysis was performed by FTIR/ATR.

Test Item(s)	A1
Polyvinyl chloride (PVC)	Negative

Notes:

(1) Negative=Undetectable, Positive=Detectable

PFOS, its salts and related compounds,PFOA, its salts

Test Method: Modified EN 17681-1:2025, analysis was performed by LC-MS or LC-MS/MS.

Test Item(s)	CAS No.	Unit(s)	MDL	A1
PFOS, its salts				
Perfluorooctane sulfonic acid (PFOS), its salts [^]	1763-23-1	mg/kg	0.010	ND
PFOS-related compounds				
N-ethylperfluoro-1-octanesulfonamide (N-EtFOSA)	4151-50-2	mg/kg	0.010	ND
N-methylperfluoro-1-octanesulfonamide (N-MeFOSA)	31506-32-8	mg/kg	0.010	ND
2-(N-ethylperfluoro-1-octanesulfonamido)-ethanol (N-EtFOSE)	1691-99-2	mg/kg	0.010	ND
2-(N-methylperfluoro-1-octanesulfonamido)-ethanol (N-MeFOSE)	24448-09-7	mg/kg	0.010	ND
Perfluorooctane Sulfonamide (PFOSA), its salts [^]	754-91-6	mg/kg	0.010	ND
Perfluorooctane sulfonamidoacetic Acid (FOSAA), its salts [^]	2806-24-8	mg/kg	0.010	ND
N-Methylperfluoro-1-octanesulfonamidoacetic Acid (N-MeFOSAA), its salts [^]	2355-31-9	mg/kg	0.010	ND
N-Ethylperfluorooctane sulfonamidoacetic Acid (N-EtFOSAA), its salts [^]	2991-50-6	mg/kg	0.010	ND
Sum of PFOS-related compounds	-	mg/kg	-	ND
PFOA, its salts				
Perfluorooctanoic acid (PFOA), its salts [^]	335-67-1	mg/kg	0.010	ND



Unless otherwise agreed in writing, this document is issued by the Company subject to its General Conditions of Service printed overleaf, available on request or accessible at <https://www.sgs.com/en/Terms-and-Conditions>. Attention is drawn to the limitation of liability, indemnification and jurisdiction issues defined therein. Any holder of this document is advised that information contained herein reflects the Company's findings at the time of its intervention only and within the limits of Client's instructions, if any. The Company's sole responsibility is to its Client and this document does not exonerate parties to a transaction from exercising all their rights and obligations under the transaction documents. This document cannot be reproduced except in full, without prior written approval of the Company. Any unauthorized alteration, forgery or falsification of the content or appearance of this document is unlawful and offenders may be prosecuted to the fullest extent of the law. Unless otherwise stated the results shown in this test report refer only to the sample(s) tested.

Attention: To check the authenticity of testing /inspection report & certificate, please contact us at telephone: (86-755) 8307 1443, or email: CN.Doccheck@sgs.com

SGS-CSI Standards Technical Services (Shanghai) Co., Ltd.
Chemical Laboratories

3rd Building, No. 889 Yishan Road Xuhui District, Shanghai China 200233
中国·上海·徐汇区宜山路889号3号楼 邮编: 200233

t E&E (86-21) 61402553 f E&E (86-21) 64953679 www.sgsgroup.com.cn
t HL (86-21) 61402594 f HL (86-21) 61156899 sgs.china@sgs.com

Notes:

(1) ^=Substances refer to its salts/derivative listed in below table.

Substances Name	CAS No.
PFOS, its salts & derivatives	
Perfluorooctane sulfonic acid (PFOS)	1763-23-1
Potassium Perfluorooctanesulfonate (PFOS-K)	2795-39-3
Perfluorooctanesulfonic acid, lithium salt (PFOS-Li)	29457-72-5
Sodium perfluorooctanesulfonate (PFOS-Na)	4021-47-0
Ammonium perfluorooctanesulfonate (PFOS-NH ₄)	29081-56-9
Perfluorooctane sulfonate diethanolamine salt (PFOS-NH ₂ (C ₂ H ₄ OH) ₂)	70225-14-8
Perfluorooctanesulfonic acid, tetraethylammonium salt (PFOS-N(C ₂ H ₅) ₄)	56773-42-3
N-decyl-N,N-dimethyldecyl-1-aminium 1,1,2,2,3,3,4,4,5,5,6,6,7,7,8,8,8-heptadecafluorooctane-1-sulfonate (PFOS-N(C ₁₀ H ₂₁) ₂ (CH ₃) ₂)	251099-16-8
TetrabutylAmmonium perfluorooctanesulfonate (PFOS-N(C ₄ H ₉) ₄)	111873-33-7
Perfluorooctane Sulfonyl fluoride (PFOS-F)	307-35-7
Magnesium bis(heptadecafluorooctanesulphonate) (PFOS-Mg)	91036-71-4
Piperidine 1,1,2,2,3,3,4,4,5,5,6,6,7,7,8,8,8-heptadecafluorooctanesulfonate	71463-74-6
Perfluorooctanesulfonate	45298-90-6
Triethylammonium perfluorooctane sulfonate (PFOS-N(C ₂ H ₅) ₃)	54439-46-2
Tetramethylammonium perfluorooctane sulfonate (PFOS-N(CH ₃) ₄)	56773-44-5
N,N,N-Tripropylpentan-1-aminium heptadecafluorooctane-1-sulfonate (PFOS-N(C ₃ H ₇) ₃ (C ₅ H ₁₁))	56773-56-9
N,N-Dibutyl-N-methylbutan-1-aminium heptadecafluorooctane-1-sulfonate (PFOS-N(C ₄ H ₉) ₃ (CH ₃))	124472-68-0
Iodonium, bis[4-(1,1-dimethylethyl)phenyl]-, salt with perfluoro-1-octanesulfonic acid (1:1)	213740-80-8
Diphenyl(2,4,6-trimethylphenyl)sulfonium perfluoro-1-octanesulfonate	258341-99-0
1-Hexadecylpyridinium perfluoro-1-octanesulfonate	334529-63-4
N,N,N-Triethyldecyl-1-aminium heptadecafluorooctane-1-sulfonate	773895-92-4
Tetrabutylphosphonium perfluorooctane sulfonate (PFOS-P (C ₄ H ₉) ₄)	2185049-59-4
Perfluorooctanesulfonic acid diethylamine salt (PFOS-C ₄ H ₁₁ N)	2205029-08-7
heptyldimethyl{2-[(2-methylprop-2-enoyl)oxy]ethyl}azanium heptadecafluorooctane-1-sulfonate (PFOS-C ₁₅ H ₃₀ NO ₂)	1203998-97-3
Perfluorooctane sulfonic anhydride (PFOSAN)	423-92-7
Perfluoro-1-octanesulfonyl chloride (PFOS-Cl)	423-60-9
FOSAA, its salts	
Perfluorooctane sulfonamidoacetic Acid (FOSAA)	2806-24-8
N-[(Perfluorooctyl)sulfonyl]glycinate (FOSAA(anion))	909405-47-6
N-[(Perfluorooctyl)sulfonyl]glycine potassium salt (1:1) (FOSAA-K)	75260-69-4
N-[(Perfluorooctyl)sulfonyl]glycine sodium salt (1:1) (FOSAA-Na)	115716-87-5
N-MeFOSAA, its salts	
N-Methylperfluoro-1-octanesulfonamidoacetic Acid (N-MeFOSAA)	2355-31-9
2-(N-Methylperfluorooctanesulfonamido)acetate (N-Me-FOSAA(anion))	909405-48-7
Potassium N-((heptadecafluorooctyl)sulphonyl)-N-methylglycinate (N-Me-FOSAA-K)	70281-93-5
N-EtFOSAA, its salts	
N-Ethylperfluorooctane sulfonamidoacetic Acid (N-EtFOSAA)	2991-50-6



Unless otherwise agreed in writing, this document is issued by the Company subject to its General Conditions of Service printed overleaf, available on request or accessible at <https://www.sgs.com/en/Terms-and-Conditions>. Attention is drawn to the limitation of liability, indemnification and jurisdiction issues defined therein. Any holder of this document is advised that information contained hereon reflects the Company's findings at the time of its intervention only and within the limits of Client's instructions, if any. The Company's sole responsibility is to its Client and this document does not exonerate parties to a transaction from exercising all their rights and obligations under the transaction documents. This document cannot be reproduced except in full, without prior written approval of the Company. Any unauthorized alteration, forgery or falsification of the content or appearance of this document is unlawful and offenders may be prosecuted to the fullest extent of the law. Unless otherwise stated the results shown in this test report refer only to the sample(s) tested.

Attention: To check the authenticity of testing / inspection report & certificate, please contact us at telephone: (86-755) 8307 1443, or email: CN.Doccheck@sgs.com

SGS-CSI (Shanghai) Technical Services (Shanghai) Co., Ltd. 3rd Building, No.889 Yishan Road Xuhui District, Shanghai China 200233 t E&E (86-21) 61402553 f E&E (86-21) 64953679 www.sgsgroup.com.cn
 中国·上海·徐汇区宜山路889号3号楼 邮编: 200233 t HL (86-21) 61402594 f HL (86-21) 61156899 sgs.china@sgs.com

Test Report

No.: SHAEC25018974601

Date: Aug 01, 2025

Page 7 of 21

Glycine, N-ethyl-N-[(heptadecafluorooctyl)sulfonyl]-, potassium salt (N-Et-FOSAA-K)	2991-51-7
2-(N-Ethyl-perfluorooctanesulfonamido)acetate (N-Et-FOSAA(anion))	909405-49-8
Ammonium 2-(N-ethylperfluorooctanesulfonamido)acetate (N-Et-FOSAA-NH ₄)	2991-52-8
Sodium 2-(N-ethylperfluorooctanesulfonamido)acetate (N-Et-FOSAA-Na)	3871-50-9
PFOA, its salts	
Perfluorooctane Sulfonamide (PFOA)	754-91-6
Perfluorooctanesulfonamide lithium salt (1:1) (PFOA-Li)	76752-79-9
Perfluorooctanesulfonamide Sodium salt (1:1) (PFOA-Na)	76752-78-8
Perfluorooctanesulfonamide Potassium salt (1:1) (PFOA-K)	76752-70-0
Perfluorooctanesulfonamide Ammonium salt (1:1) (PFOA-NH ₄)	76752-72-2
Heptadecafluorooctane-1-sulphonamide, compound with triethylamine (1:1) (PFOA-C ₆ H ₁₅ N)	76752-82-4
PFOA, its salts & derivatives	
Perfluorooctanoic acid (PFOA)	335-67-1
Sodium perfluorooctanoate (PFOA-Na)	335-95-5
Potassium perfluorooctanoate (PFOA-K)	2395-00-8
Silver perfluorooctanoate (PFOA-Ag)	335-93-3
Perfluorooctanoyl fluoride (PFOA-F)	335-66-0
Ammonium pentadecafluorooctanoate (APFO)	3825-26-1
Lithium perfluorooctanoate (PFOA-Li)	17125-58-5
Cobalt perfluorooctanoate (PFOA-Co)	35965-01-6
Cesium perfluorooctanoate (PFOA-Cs)	17125-60-9
Octanoic acid, 2,2,3,3,4,4,5,5,6,6,7,7,8,8,8-pentadecafluoro-, chromium(3+) (PFOA-Cr(3+))	68141-02-6
Pentadecafluorooctanoic acid--piperazine (2/1) (PFOA-NH(C ₄ H ₁₀ N))	423-52-9
Pentadecafluorooctanoate (anion)	45285-51-6
Perfluorooctanoic Anhydride	33496-48-9
N,N,N-Triethylethanaminium perfluorooctanoate	98241-25-9
Perfluorooctanoate N,N,N-Trimethylmethanaminium	32609-65-7
Tetrapropylammonium perfluorooctanoate	277749-00-5
Potassium pentadecafluorooctanoate--water (1/1/2) (PFOA-K(H ₂ O) ₂)	98065-31-7
Perfluorooctanoic acid compd. with ethanamine (1:1) (PFOA-C ₂ H ₇ N)	1376936-03-6
Pentadecafluorooctanoic acid--pyridine (1/1) (PFOA-C ₅ H ₅ N)	95658-47-2
pentadecafluorooctanoic acid- 1-phenylpiperazine(1:1) (PFOA-C ₁₀ H ₁₄ N ₂)	1514-68-7
N,N,N-Trimethyloctan-1-aminium pentadecafluorooctanoate (PFOA-C ₁₁ H ₂₆ N)	927835-01-6
Pentadecafluorooctanoyl chloride (PFOA-Cl)	335-64-8

Phthalates

Test Method: With reference to EN 14372:2004, analysis was performed by GC-MS.

Test Item(s)	CAS No.	Unit(s)	MDL	A1
Di-butyl Phthalate (DBP)	84-74-2	%	0.003	ND
Benzyl Butyl Phthalate (BBP)	85-68-7	%	0.003	ND



Unless otherwise agreed in writing, this document is issued by the Company subject to its General Conditions of Service printed overleaf, available on request or accessible at <https://www.sgs.com/en/Terms-and-Conditions>. Attention is drawn to the limitation of liability, indemnification and jurisdiction issues defined therein. Any holder of this document is advised that information contained herein reflects the Company's findings at the time of its intervention only and within the limits of Client's instructions, if any. The Company's sole responsibility is to its Client and this document does not exonerate parties to a transaction from exercising all their rights and obligations under the transaction documents. This document cannot be reproduced except in full, without prior written approval of the Company. Any unauthorized alteration, forgery or falsification of the content or appearance of this document is unlawful and offenders may be prosecuted to the fullest extent of the law. Unless otherwise stated the results shown in this test report refer only to the sample(s) tested.

Attention: To check the authenticity of testing /inspection report & certificate, please contact us at telephone: (86-755) 8307 1443, or email: CN.Doccheck@sgs.com

SGS-CSI Standards Technical Services (Shanghai) Co., Ltd.
Chemical Laboratories

3rd Building, No. 889 Yishan Road Xuhui District, Shanghai China 200233
中国·上海·徐汇区宜山路889号3号楼 邮编: 200233

tE&E (86-21) 61402553 fE&E (86-21) 64953679 www.sgsgroup.com.cn
tHL (86-21) 61402594 fHL (86-21) 61156899 sgs.china@sgs.com

Test Report

No.: SHAEC25018974601

Date: Aug 01, 2025

Page 8 of 21

Test Item(s)	CAS No.	Unit(s)	MDL	A1
Di-2-Ethyl Hexyl Phthalate (DEHP)	117-81-7	%	0.003	ND
Diisononyl Phthalate (DINP)	28553-12-0 /68515-48-0	%	0.010	ND
Di-n-octyl Phthalate (DNOP)	117-84-0	%	0.003	ND
Diisodecyl Phthalate (DIDP)	26761-40-0 /68515-49-1	%	0.010	ND
Dimethyl Phthalates (DMP)	131-11-3	%	0.003	ND
Diethyl Phthalates (DEP)	84-66-2	%	0.003	ND
Diisobutyl Phthalates (DIBP)	84-69-5	%	0.003	ND
Di-n-pentyl Phthalates (DnPP)	131-18-0	%	0.003	ND
Dicyclohexyl Phthalates (DCHP)	84-61-7	%	0.003	ND
Diphenyl Phthalates (DPhP)	84-62-8	%	0.003	ND
Dibenzyl Phthalates (DBzP)	523-31-9	%	0.003	ND
Diiso-octyl Phthalates (DIOP)	27554-26-3	%	0.010	ND
Dipropyl Phthalates (DPrP)	131-16-8	%	0.003	ND
Dinonyl Phthalates (DNP)	84-76-4	%	0.003	ND
Di-n-hexyl Phthalates (DnHP)	84-75-3	%	0.003	ND

Red Phosphorus

Test Method: With reference to SGS In house method, analysis was performed by ICP-OES and Pyrolysis-GC-MS.

Test Item(s)	CAS No.	Unit(s)	MDL	A1
Red Phosphorus	7723-14-0	mg/kg	500	ND

Notes:

(1) The testing result is based on the worst-case scenario, and confirmed by Pyrolysis-GC-MS. Unless otherwise stated, the decision rule for conformity reporting is based on Binary Statement for Simple Acceptance Rule ($w=0$) stated in ILAC-G8:09/2019.



Unless otherwise agreed in writing, this document is issued by the Company subject to its General Conditions of Service printed overleaf, available on request or accessible at <https://www.sgs.com/en/Terms-and-Conditions>. Attention is drawn to the limitation of liability, indemnification and jurisdiction issues defined therein. Any holder of this document is advised that information contained hereon reflects the Company's findings at the time of its intervention only and within the limits of Client's instructions, if any. The Company's sole responsibility is to its Client and this document does not exonerate parties to a transaction from exercising all their rights and obligations under the transaction documents. This document cannot be reproduced except in full, without prior written approval of the Company. Any unauthorized alteration, forgery or falsification of the content or appearance of this document is unlawful and offenders may be prosecuted to the fullest extent of the law. Unless otherwise stated the results shown in this test report refer only to the sample(s) tested.

Attention: To check the authenticity of testing /inspection report & certificate, please contact us at telephone: (86-755) 8307 1443, or email: CN.Doccheck@sgs.com

SGS-CTI (Shanghai) Technical Services (Shanghai) Co., Ltd.
Chemical Laboratories

3rd Building, No. 889 Yishan Road Xuhui District, Shanghai China 200233
中国·上海·徐汇区宜山路889号3号楼 邮编: 200233

t E&E (86-21) 61402553 f E&E (86-21) 64953679 www.sgsgroup.com.cn
t HL (86-21) 61402594 f HL (86-21) 61156899 sgs.china@sgs.com

Elements Testing Flow Chart

These samples were dissolved totally by pre-conditioning method according to below flow chart.

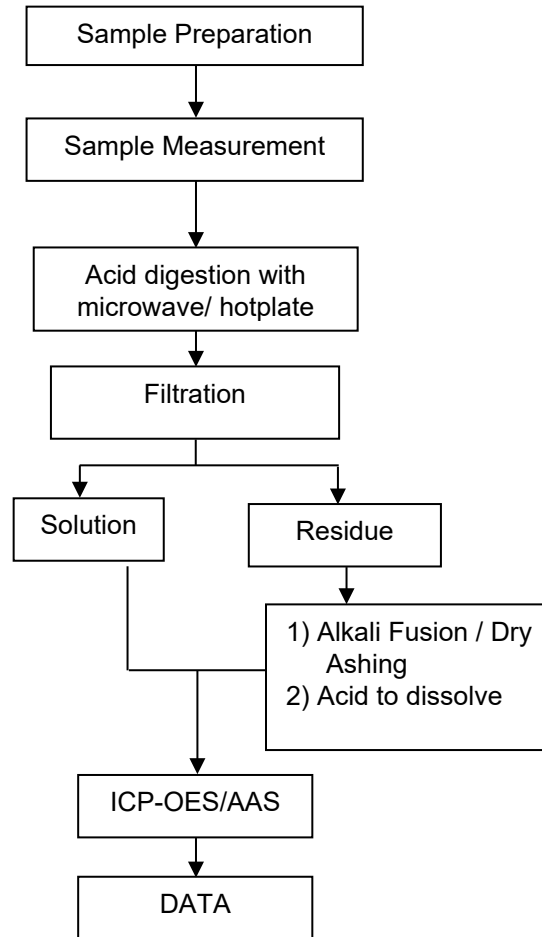

Unless otherwise agreed in writing, this document is issued by the Company subject to its General Conditions of Service printed overleaf, available on request or accessible at <https://www.sgs.com/en/Terms-and-Conditions>. Attention is drawn to the limitation of liability, indemnification and jurisdiction issues defined therein. Any holder of this document is advised that information contained hereon reflects the Company's findings at the time of its intervention only and within the limits of Client's instructions, if any. The Company's sole responsibility is to its Client and this document does not exonerate parties to a transaction from exercising all their rights and obligations under the transaction documents. This document cannot be reproduced except in full, without prior written approval of the Company. Any unauthorized alteration, forgery or falsification of the content or appearance of this document is unlawful and offenders may be prosecuted to the fullest extent of the law. Unless otherwise stated the results shown in this test report refer only to the sample(s) tested.

Attention: To check the authenticity of testing /inspection report & certificate, please contact us at telephone: (86-755) 8307 1443, or email: CN.Doccheck@sgs.com

Hexavalent Chromium (Cr(VI)) Testing Flow Chart

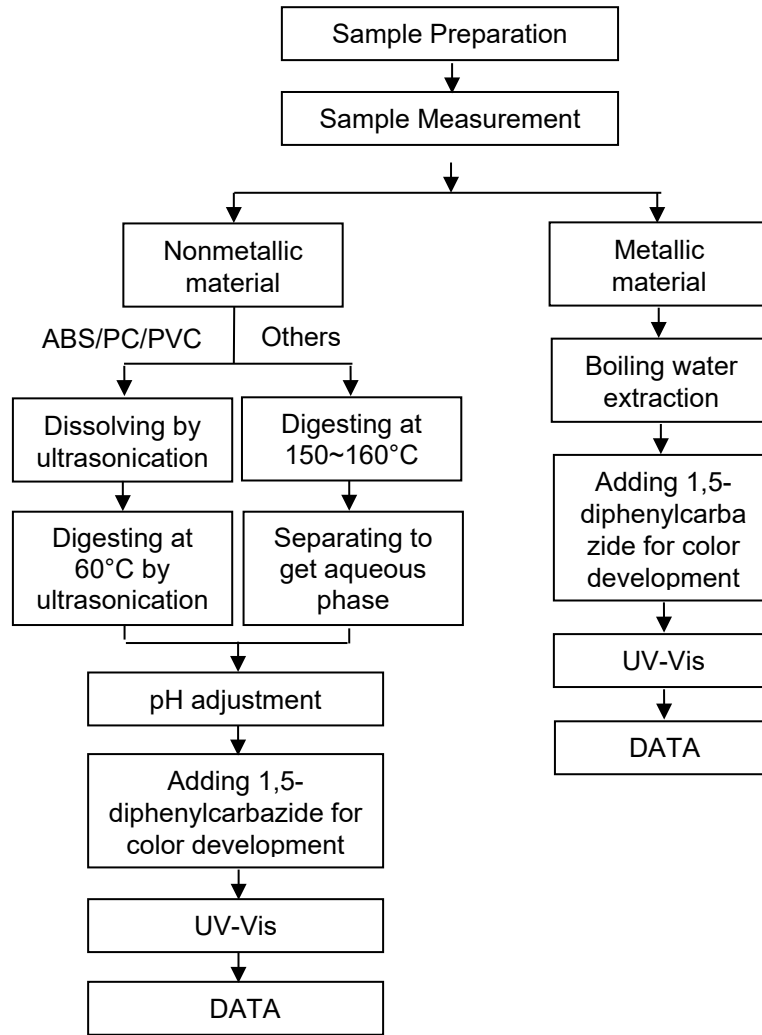

Unless otherwise agreed in writing, this document is issued by the Company subject to its General Conditions of Service printed overleaf, available on request or accessible at <https://www.sgs.com/en/Terms-and-Conditions>. Attention is drawn to the limitation of liability, indemnification and jurisdiction issues defined therein. Any holder of this document is advised that information contained hereon reflects the Company's findings at the time of its intervention only and within the limits of Client's instructions, if any. The Company's sole responsibility is to its Client and this document does not exonerate parties to a transaction from exercising all their rights and obligations under the transaction documents. This document cannot be reproduced except in full, without prior written approval of the Company. Any unauthorized alteration, forgery or falsification of the content or appearance of this document is unlawful and offenders may be prosecuted to the fullest extent of the law. Unless otherwise stated the results shown in this test report refer only to the sample(s) tested.

Attention: To check the authenticity of testing /inspection report & certificate, please contact us at telephone: (86-755) 8307 1443, or email: CN.Doccheck@sgs.com

PBB/PBDE/Phthalates Testing Flow Chart

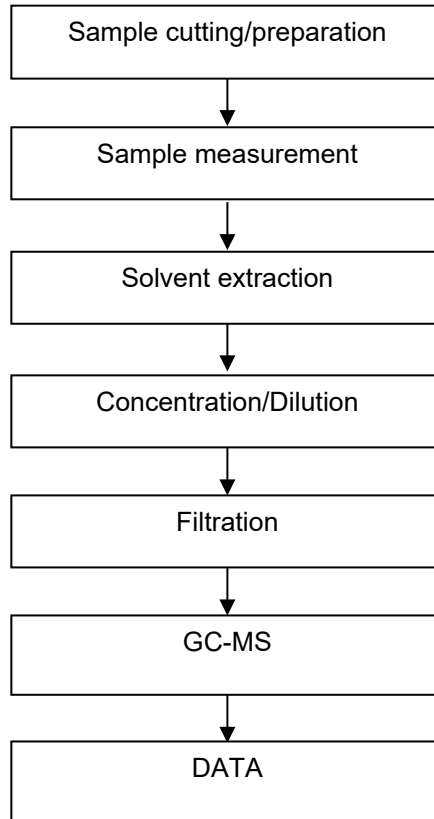

Chlorinated Paraffin Testing Flow Chart

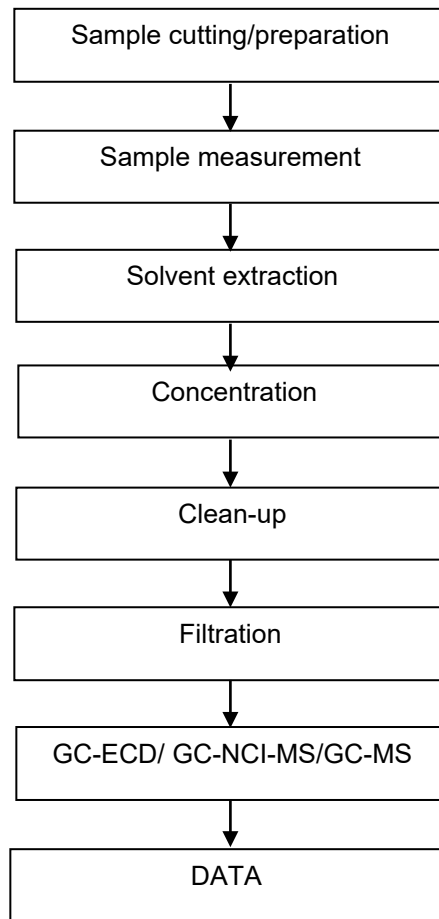

Unless otherwise agreed in writing, this document is issued by the Company subject to its General Conditions of Service printed overleaf, available on request or accessible at <https://www.sgs.com/en/Terms-and-Conditions>. Attention is drawn to the limitation of liability, indemnification and jurisdiction issues defined therein. Any holder of this document is advised that information contained hereon reflects the Company's findings at the time of its intervention only and within the limits of Client's instructions, if any. The Company's sole responsibility is to its Client and this document does not exonerate parties to a transaction from exercising all their rights and obligations under the transaction documents. This document cannot be reproduced except in full, without prior written approval of the Company. Any unauthorized alteration, forgery or falsification of the content or appearance of this document is unlawful and offenders may be prosecuted to the fullest extent of the law. Unless otherwise stated the results shown in this test report refer only to the sample(s) tested.

Attention: To check the authenticity of testing /inspection report & certificate, please contact us at telephone: (86-755) 8307 1443, or email: CN.Doccheck@sgs.com

Elements Testing Flow Chart

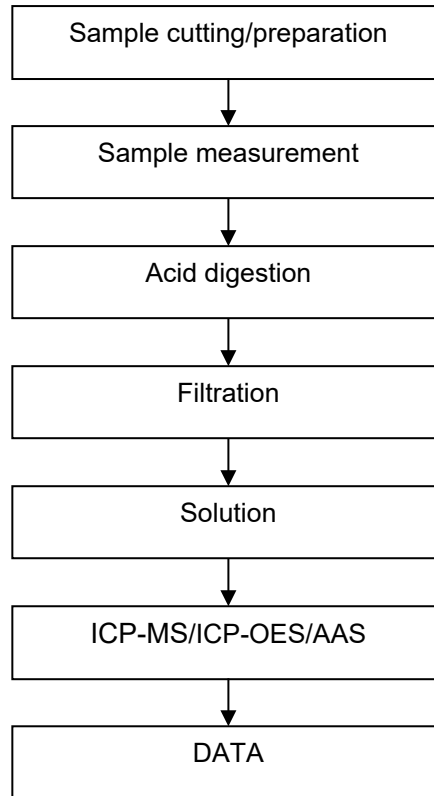

Unless otherwise agreed in writing, this document is issued by the Company subject to its General Conditions of Service printed overleaf, available on request or accessible at <https://www.sgs.com/en/Terms-and-Conditions>. Attention is drawn to the limitation of liability, indemnification and jurisdiction issues defined therein. Any holder of this document is advised that information contained hereon reflects the Company's findings at the time of its intervention only and within the limits of Client's instructions, if any. The Company's sole responsibility is to its Client and this document does not exonerate parties to a transaction from exercising all their rights and obligations under the transaction documents. This document cannot be reproduced except in full, without prior written approval of the Company. Any unauthorized alteration, forgery or falsification of the content or appearance of this document is unlawful and offenders may be prosecuted to the fullest extent of the law. Unless otherwise stated the results shown in this test report refer only to the sample(s) tested.

Attention: To check the authenticity of testing /inspection report & certificate, please contact us at telephone: (86-755) 8307 1443, or email: CN.Doccheck@sgs.com

SGS-CSTC Standards Technical Services (Shanghai) Co., Ltd.
Chemical Laboratories

3rd Building, No. 889 Yishan Road Xuhui District, Shanghai China 200233 t E&E (86-21) 61402553 f E&E (86-21) 64953679 www.sgsgroup.com.cn
中国·上海·徐汇区宜山路889号3号楼 邮编: 200233 t HL (86-21) 61402594 f HL (86-21) 61156899 sgs.china@sgs.com

Halogen Testing Flow Chart

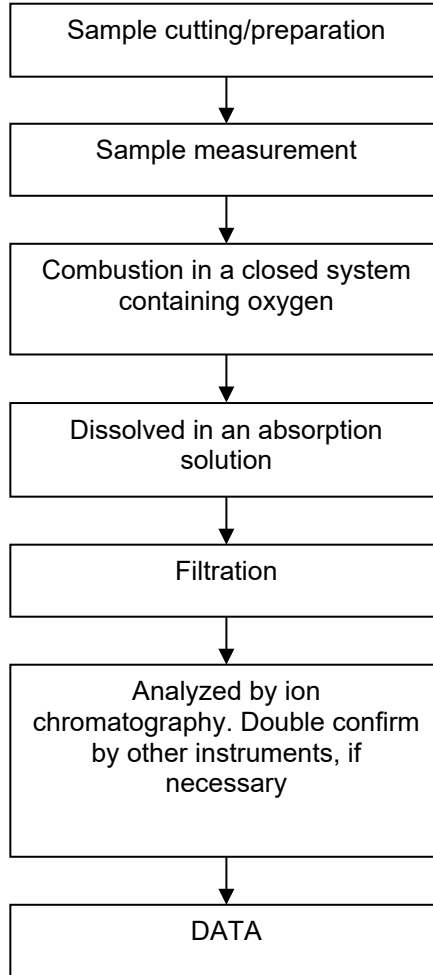

HBCDD Testing Flow Chart

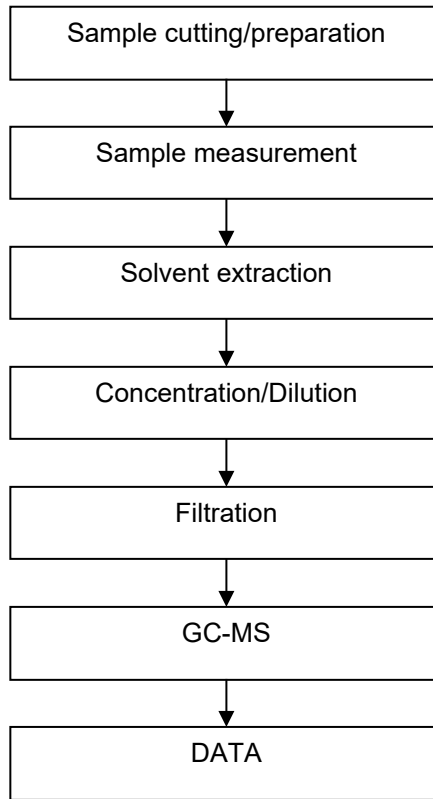

SGS-CSI Standards Technical Services (Shanghai) Co., Ltd.
Chemical Laboratories

Unless otherwise agreed in writing, this document is issued by the Company subject to its General Conditions of Service printed overleaf, available on request or accessible at <https://www.sgs.com/en/Terms-and-Conditions>. Attention is drawn to the limitation of liability, indemnification and jurisdiction issues defined therein. Any holder of this document is advised that information contained hereon reflects the Company's findings at the time of its intervention only and within the limits of Client's instructions, if any. The Company's sole responsibility is to its Client and this document does not exonerate parties to a transaction from exercising all their rights and obligations under the transaction documents. This document cannot be reproduced except in full, without prior written approval of the Company. Any unauthorized alteration, forgery or falsification of the content or appearance of this document is unlawful and offenders may be prosecuted to the fullest extent of the law. Unless otherwise stated the results shown in this test report refer only to the sample(s) tested.

Attention: To check the authenticity of testing /inspection report & certificate, please contact us at telephone: (86-755) 8307 1443, or email: CN.Doccheck@sgs.com

3rd Building, No. 889 Yishan Road Xuhui District, Shanghai China 200233 t E&E (86-21) 61402553 f E&E (86-21) 64953679 www.sgsgroup.com.cn
中国·上海·徐汇区宜山路889号3号楼 邮编: 200233 t HL (86-21) 61402594 f HL (86-21) 61156899 sgs.china@sgs.com

PCB Testing Flow Chart

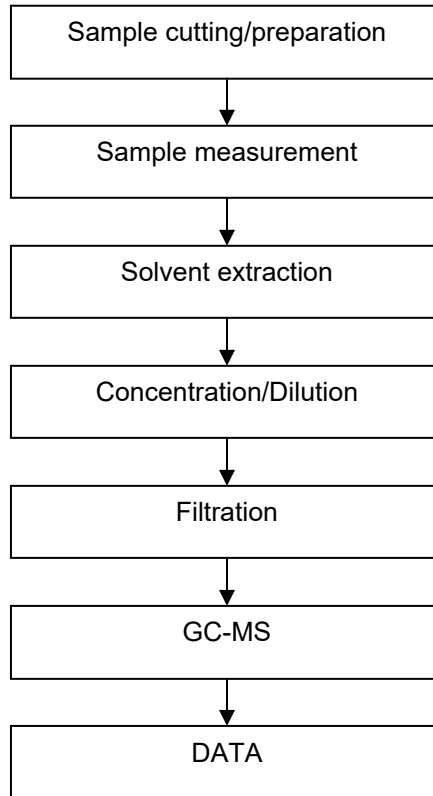

PVC Testing Flow Chart

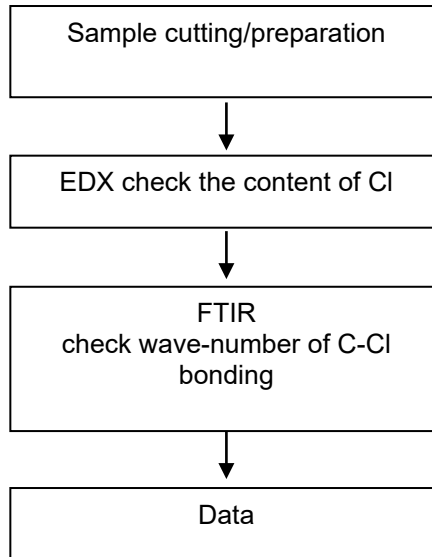

Unless otherwise agreed in writing, this document is issued by the Company subject to its General Conditions of Service printed overleaf, available on request or accessible at <https://www.sgs.com/en/Terms-and-Conditions>. Attention is drawn to the limitation of liability, indemnification and jurisdiction issues defined therein. Any holder of this document is advised that information contained hereon reflects the Company's findings at the time of its intervention only and within the limits of Client's instructions, if any. The Company's sole responsibility is to its Client and this document does not exonerate parties to a transaction from exercising all their rights and obligations under the transaction documents. This document cannot be reproduced except in full, without prior written approval of the Company. Any unauthorized alteration, forgery or falsification of the content or appearance of this document is unlawful and offenders may be prosecuted to the fullest extent of the law. Unless otherwise stated the results shown in this test report refer only to the sample(s) tested.

Attention: To check the authenticity of testing /inspection report & certificate, please contact us at telephone: (86-755) 8307 1443, or email: CN.Doccheck@sgs.com

3rd Building, No. 889 Yishan Road Xuhui District, Shanghai China 200233 t E&E (86-21) 61402553 f E&E (86-21) 64953679 www.sgsgroup.com.cn
中国·上海·徐汇区宜山路889号3号楼 邮编: 200233 t HL (86-21) 61402594 f HL (86-21) 61156899 sgs.china@sgs.com

PFASs/ PFOS/PFOA Testing Flow Chart

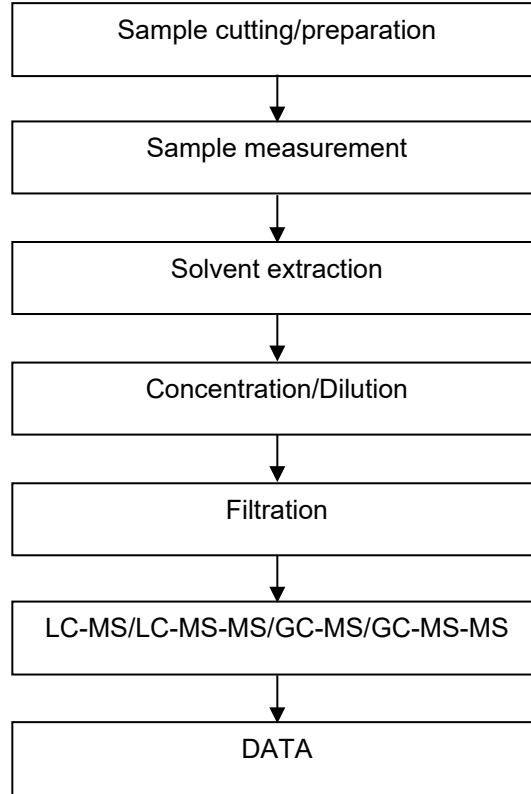

Unless otherwise agreed in writing, this document is issued by the Company subject to its General Conditions of Service printed overleaf, available on request or accessible at <https://www.sgs.com/en/Terms-and-Conditions>. Attention is drawn to the limitation of liability, indemnification and jurisdiction issues defined therein. Any holder of this document is advised that information contained hereon reflects the Company's findings at the time of its intervention only and within the limits of Client's instructions, if any. The Company's sole responsibility is to its Client and this document does not exonerate parties to a transaction from exercising all their rights and obligations under the transaction documents. This document cannot be reproduced except in full, without prior written approval of the Company. Any unauthorized alteration, forgery or falsification of the content or appearance of this document is unlawful and offenders may be prosecuted to the fullest extent of the law. Unless otherwise stated the results shown in this test report refer only to the sample(s) tested.

Attention: To check the authenticity of testing /inspection report & certificate, please contact us at telephone: (86-755) 8307 1443, or email: CN.Doccheck@sgs.com

Phthalates Testing Flow Chart

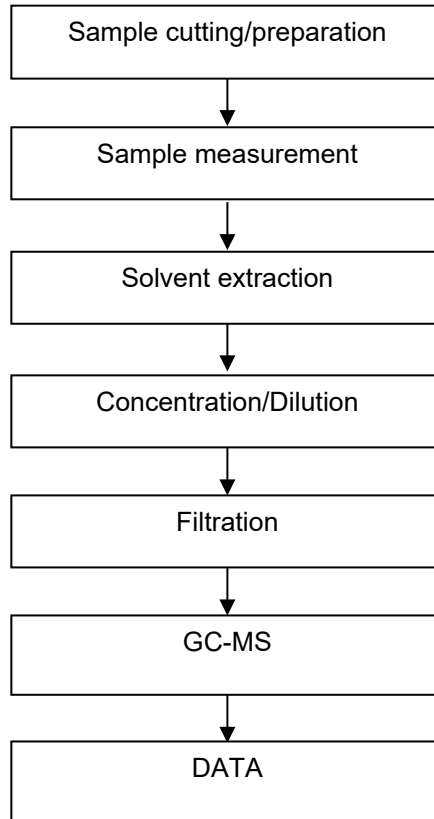

Unless otherwise agreed in writing, this document is issued by the Company subject to its General Conditions of Service printed overleaf, available on request or accessible at <https://www.sgs.com/en/Terms-and-Conditions>. Attention is drawn to the limitation of liability, indemnification and jurisdiction issues defined therein. Any holder of this document is advised that information contained hereon reflects the Company's findings at the time of its intervention only and within the limits of Client's instructions, if any. The Company's sole responsibility is to its Client and this document does not exonerate parties to a transaction from exercising all their rights and obligations under the transaction documents. This document cannot be reproduced except in full, without prior written approval of the Company. Any unauthorized alteration, forgery or falsification of the content or appearance of this document is unlawful and offenders may be prosecuted to the fullest extent of the law. Unless otherwise stated the results shown in this test report refer only to the sample(s) tested.

Attention: To check the authenticity of testing /inspection report & certificate, please contact us at telephone: (86-755) 8307 1443, or email: CN.Doccheck@sgs.com

Red Phosphorus Testing Flow Chart

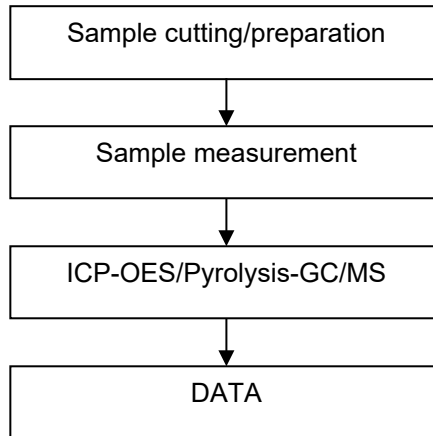

Test Report

No.: SHAEC25018974601

Date: Aug 01, 2025

Page 21 of 21

Sample Photo:

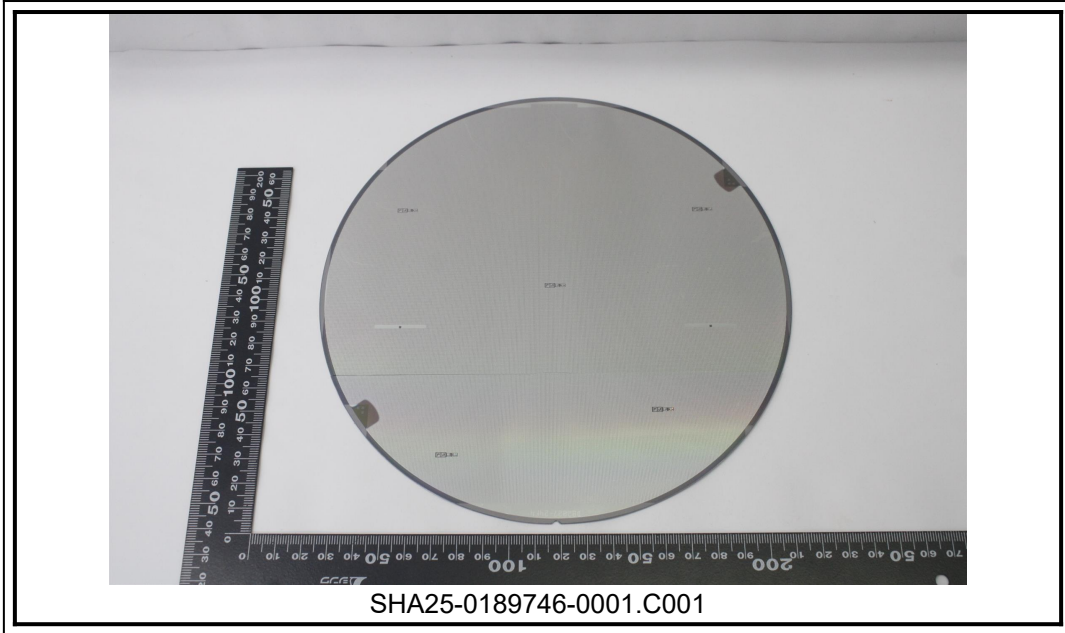

SGS authenticate the photo on original report only
*** End of Report ***



Unless otherwise agreed in writing, this document is issued by the Company subject to its General Conditions of Service printed overleaf, available on request or accessible at <https://www.sgs.com/en/Terms-and-Conditions>. Attention is drawn to the limitation of liability, indemnification and jurisdiction issues defined therein. Any holder of this document is advised that information contained hereon reflects the Company's findings at the time of its intervention only and within the limits of Client's instructions, if any. The Company's sole responsibility is to its Client and this document does not exonerate parties to a transaction from exercising all their rights and obligations under the transaction documents. This document cannot be reproduced except in full, without prior written approval of the Company. Any unauthorized alteration, forgery or falsification of the content or appearance of this document is unlawful and offenders may be prosecuted to the fullest extent of the law. Unless otherwise stated the results shown in this test report refer only to the sample(s) tested.
Attention: To check the authenticity of testing /inspection report & certificate, please contact us at telephone: (86-755) 8307 1443, or email: CN.Doccheck@sgs.com

SGS (China) Co., Ltd.
SGS Standards Technical Services (Shanghai) Co., Ltd.
Chemical Laboratories

3rd Building, No. 889 Yishan Road Xuhui District, Shanghai China 200233
中国·上海·徐汇区宜山路889号3号楼 邮编: 200233

t E&E (86-21) 61402553 f E&E (86-21) 64953679 www.sgsgroup.com.cn
t HL (86-21) 61402594 f HL (86-21) 61156899 sgs.china@sgs.com