

# KTFRDMMC36XSDEVBUG

FRDM-MC36XSD-EVB evaluation board

Rev. 1.0 — 30 August 2016

User guide

## 1 FRDM-MC36XSD-EVB

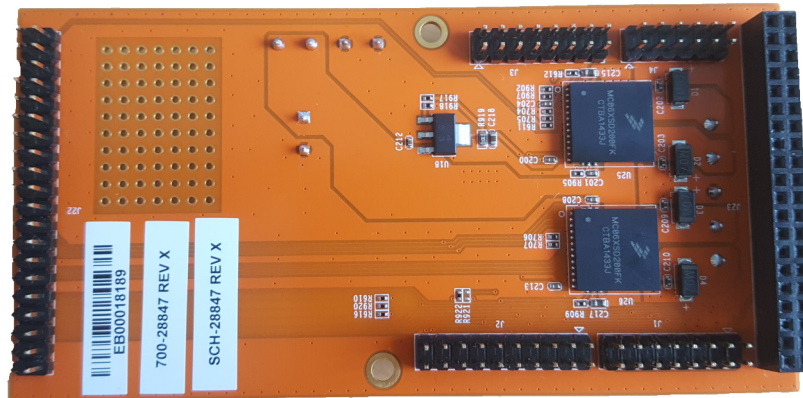

## 2 Important notice

NXP provides the enclosed product(s) under the following conditions:

This evaluation kit is intended for use of ENGINEERING DEVELOPMENT OR EVALUATION PURPOSES ONLY. It is provided as a sample IC pre-soldered to a printed circuit board to make it easier to access inputs, outputs, and supply terminals. This evaluation board may be used with any development system or other source of I/O signals by simply connecting it to the host MCU or computer board via off-the-shelf cables. This evaluation board is not a Reference Design and is not intended to represent a final design recommendation for any particular application. Final device in an application will be heavily dependent on proper printed circuit board layout and heat sinking design as well as attention to supply filtering, transient suppression, and I/O signal quality.

The goods provided may not be complete in terms of required design, marketing, and or manufacturing related protective considerations, including product safety measures typically found in the end product incorporating the goods. Due to the open construction of the product, it is the user's responsibility to take any and all appropriate precautions with regard to electrostatic discharge. In order to minimize risks associated with the customers applications, adequate design and operating safeguards must be provided by the customer to minimize inherent or procedural hazards. For any safety concerns, contact NXP sales and technical support services.

Should this evaluation kit not meet the specifications indicated in the kit, it may be returned within 30 days from the date of delivery and will be replaced by a new kit.

NXP reserves the right to make changes without further notice to any products herein. NXP makes no warranty, representation or guarantee regarding the suitability of its products for any particular purpose, nor does NXP assume any liability arising out of the application or use of any product or circuit, and specifically disclaims any and all liability, including without limitation consequential or incidental damages. "Typical" parameters can and do vary in different applications and actual performance may vary over time. All operating parameters, including "Typical", must be validated for each customer application by customer's technical experts.

NXP does not convey any license under its patent rights nor the rights of others. NXP products are not designed, intended, or authorized for use as components in systems intended for surgical implant into the body, or other applications intended to support or sustain life, or for any other application in which the failure of the NXP product could create a situation where personal injury or death may occur.

Should the Buyer purchase or use NXP products for any such unintended or unauthorized application, the Buyer shall indemnify and hold NXP and its officers, employees, subsidiaries, affiliates, and distributors harmless against all claims, costs, damages, and expenses, and reasonable attorney fees arising out of, directly or indirectly, any claim of personal injury or death associated with such unintended or unauthorized use, even if such claim alleges NXP was negligent regarding the design or manufacture of the part. NXP and the NXP logo are trademarks of NXP B.V. All other product or service names are the property of their respective owners. © 2016 NXP B.V.

### 3 Overview of the FRDM-MC36XSD-EVB development environment

The FRDM-MC36XSD-EVB provides an evaluation platform for developing systems based on NXP's MC06XSD200 dual high-side switch device. DC components—such as brushed motors, light bulbs and fans—can be connected to the board as part of the development environment. Designers access the functionality of the on-board MC06XSD200 through a software interface on a host PC. Communication between the PC and the FRDM-MC36XSD-EVB is managed by a companion board connected to the evaluation board. There are three possible options in selecting the type of companion board and the corresponding software interface.

#### Option 1—The FRDM-KL25Z and CodeWarrior

This option uses NXP's FRDM-KL25Z board attached to the FRDM-MC36XSD-EVB through the Arduino™ connectors on each board. In this configuration, the KL25Z serves primarily as an SPI communication link between the evaluation board and the host PC. The software interface is through NXP's CodeWarrior IDE (Integrated Design Environment) and the CodeWarrior 36VeXtremeSwitch component. A CodeWarrior example project, available as a .zip file on NXP's website, incorporates the 36eXtremeSwitch component and demonstrates a typical CodeWarrior implementation using the FRDM-MC36XSD-EVB. Designers can connect components to the evaluation board and modify the code in the example to suit their development needs.

#### Option 2—Raspberry Pi and Python

With this option, the Raspberry Pi 2 Model B multi-functional board is attached to the FRDM-MC36XSD-EVB through the GPIO connectors on each board. The designer downloads a microcode image of the Raspberry Pi operating system from NXP's website and flashes the image to the Raspberry Pi SD memory card. This image incorporates all the drivers and support required to interact with the FRDM-MC36XSD-EVB. Raspberry Pi's USB and HDMI ports provide connectivity to a keyboard, mouse and monitor, which allows users to access the operating system and execute Python code to interact with the evaluation board and the components connected to it. A Python source code demo, included in the image downloaded from NXP's website, can be modified to fit the designer's needs.

#### Option 3—RIoTboard and Python

This option is similar to Option 2, with the RIoTboard serving as the companion board. Both boards are linked through their respective GPIO connectors. NXP's website provides a control program image that the designer downloads and flashes to the RIoTboard's memory. The RIoTboard connects to a host PC through a USB port. The designer activates a terminal emulator on the host PC and executes Python code to interact with the evaluation board and its connected components. Python source code for this option is included in the image downloaded from NXP's website.

## 4 Getting started

### 4.1 Kit contents/packing list

The FRDM-MC36XSD-EVB contents include:

- Assembled and tested evaluation board/module in anti-static bag
- Quick start guide

### 4.2 Jump start

NXP's analog product development boards provide an easy-to-use platform for evaluating NXP products. The boards support a range of analog, mixed-signal and power solutions. They incorporate monolithic ICs and system-in-package devices that use proven high-volume SMARTMOS technology. NXP products offer longer battery life, a smaller form factor, reduced component counts, lower cost and improved performance in powering state of the art systems.

1. Go to <http://www.nxp.com/FRDM-MC36XSD-EVB>.
2. Review your Tools Summary Page.
3. Locate and click:

#### Jump Start Your Design

4. Download the documents, software and other information.

Once the files are downloaded, review the user guide in the bundle. The user guide includes setup instructions, BOM and schematics. Jump start bundles are available on each tool summary page with the most relevant and current information. The information includes everything needed for design.

### 4.3 Required equipment

This kit requires the following items:

- 3/16" blade screwdriver for connecting the cables
- DC power supply: 5.0 V to 36 V with up to 20 A current handling capability, depending on motor requirements
- Typical loads (DC motor, bulbs, power resistors or inductive load with 20 A and 36 V max operation)
- One of the following hardware for SPI communication, configuration and control:
  - FRDM-KL25Z Freedom Development Platform
  - Raspberry Pi 2 Model B
  - RIoTboard

This board is also compatible with Arduino™ Uno and Leonardo but no drivers are provided for this hardware.

#### 4.4 System requirements

The kit requires the following to function properly with the software:

- USB enabled computer running Windows XP or newer

## 5 Getting to know the hardware

---

### 5.1 Board overview

The FRDM-MC36XSD-EVB evaluation kit exercises all the functions of the MC06XSD200 device. It features two devices for a total of four power outputs that can be connected in parallel 2-by-2.

The board can be used in conjunction either with a FRDM-KL25Z board (connected to a PC's USB port) or with RIoTboard or Raspberry Pi.

Configuration, control and status monitoring of both MC06XSD200 is accomplished by using the board's SPI communication capabilities or, alternatively, by configuring the GPIO pins as direct input pins.

### 5.2 Board features

The FRDM-MC36XSD-EVB board supports evaluation of all the functionality available on NXP's MC06XSD200. The board features the following:

- Four configurable power outputs with current, voltage and overtemperature protection
- Power connectors to control various types of external loads
- 3.3 V voltage regulator
- Solder paste area reserved for soldering in additional components
- Freewheeling diodes on all power channels
- 220  $\mu$ F tank capacitor on supply terminal to help to maintain voltage during current inrush

### 5.3 Block diagram

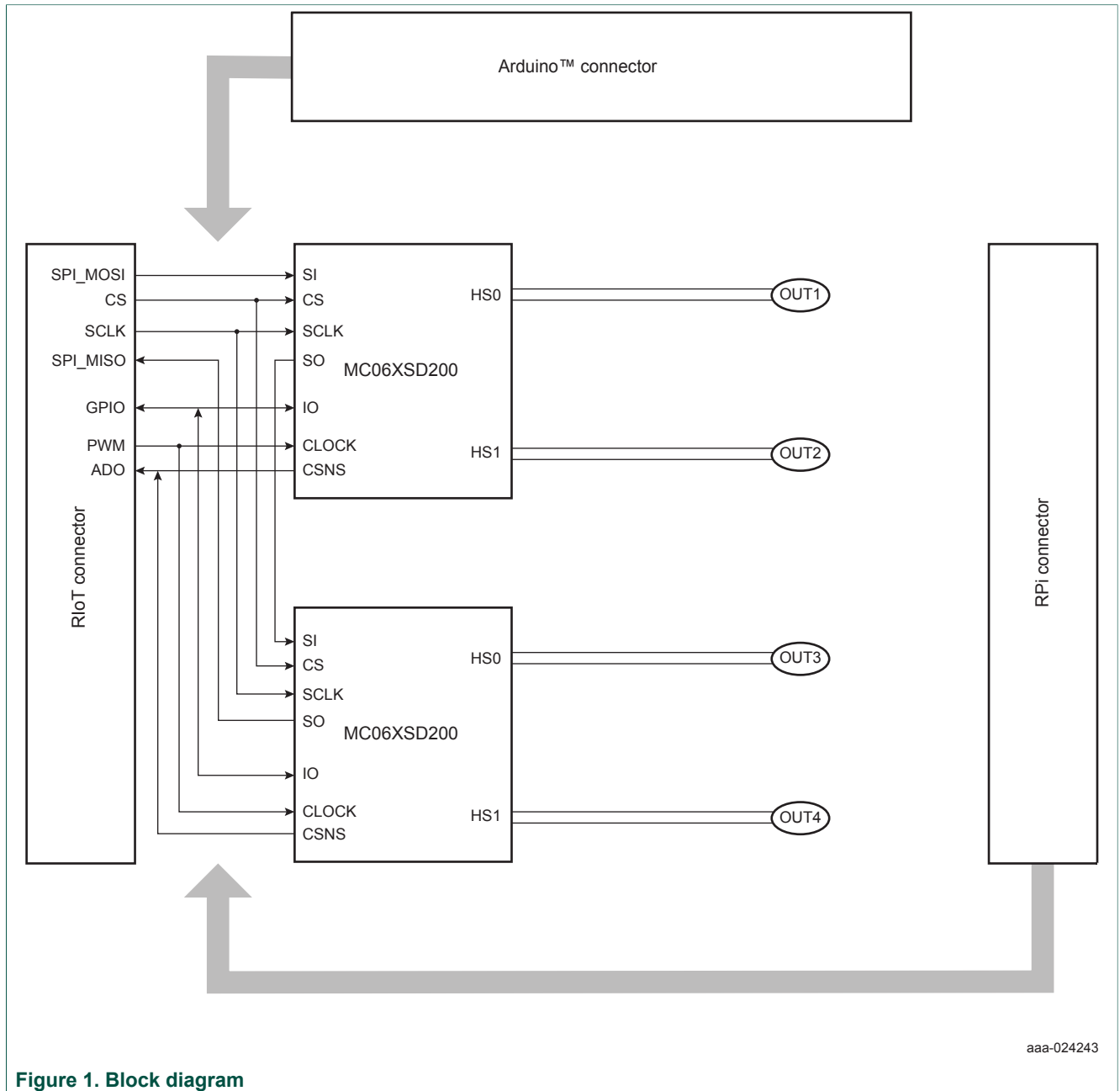

Figure 1. Block diagram

### 5.4 Device features

This evaluation board features the following NXP product:

**Table 1. Device features**

| Device     | Description   | Features  |
|------------|---|---|
| MC06XSD200 | The MC06XSD200 is a dual High-side Switch Power IC, enhanced with SPI configuration, protection and diagnostic capabilities | <ul style="list-style-type: none"> <li>• Up to 12 A steady-state current per channel</li> <li>• Separate bulb and DC motor latched overcurrent handling</li> <li>• Sleep mode with minimal supply current (&lt; 10 µA @ 24 V)</li> <li>• Individually programmable internal/external PWM clock signals</li> <li>• Overcurrent, short-circuit, and overtemperature protection with programmable auto-retry functions</li> <li>• Accurate temperature and current sensing</li> <li>• Open-load detection (channel in OFF and ON state), also for LED applications (7.0 mA typ.)</li> <li>• Normal operating range: 8.0 - 36 V, extended range: 6.0 - 58 V</li> <li>• 3.3 V and 5.0 V compatible 16-bit SPI port for device control, configuration and diagnostics at rates up to 8.0 MHz</li> </ul> |

For more details on the MC06XSD200, refer to the datasheet: [http://www.nxp.com/files/analog/doc/data\\_sheet/MC06XSD200.pdf](http://www.nxp.com/files/analog/doc/data_sheet/MC06XSD200.pdf)



### 5.5 Application diagram

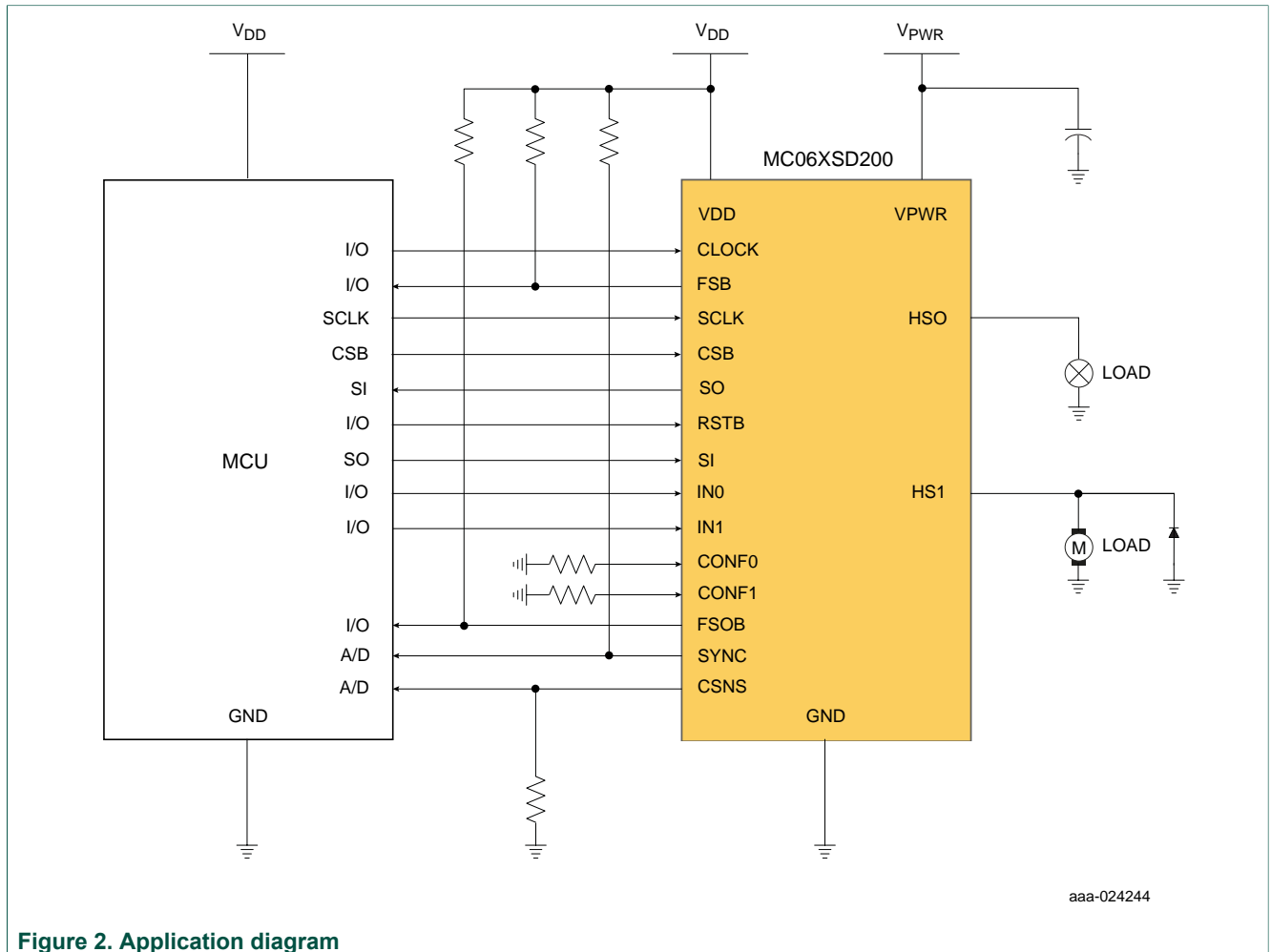
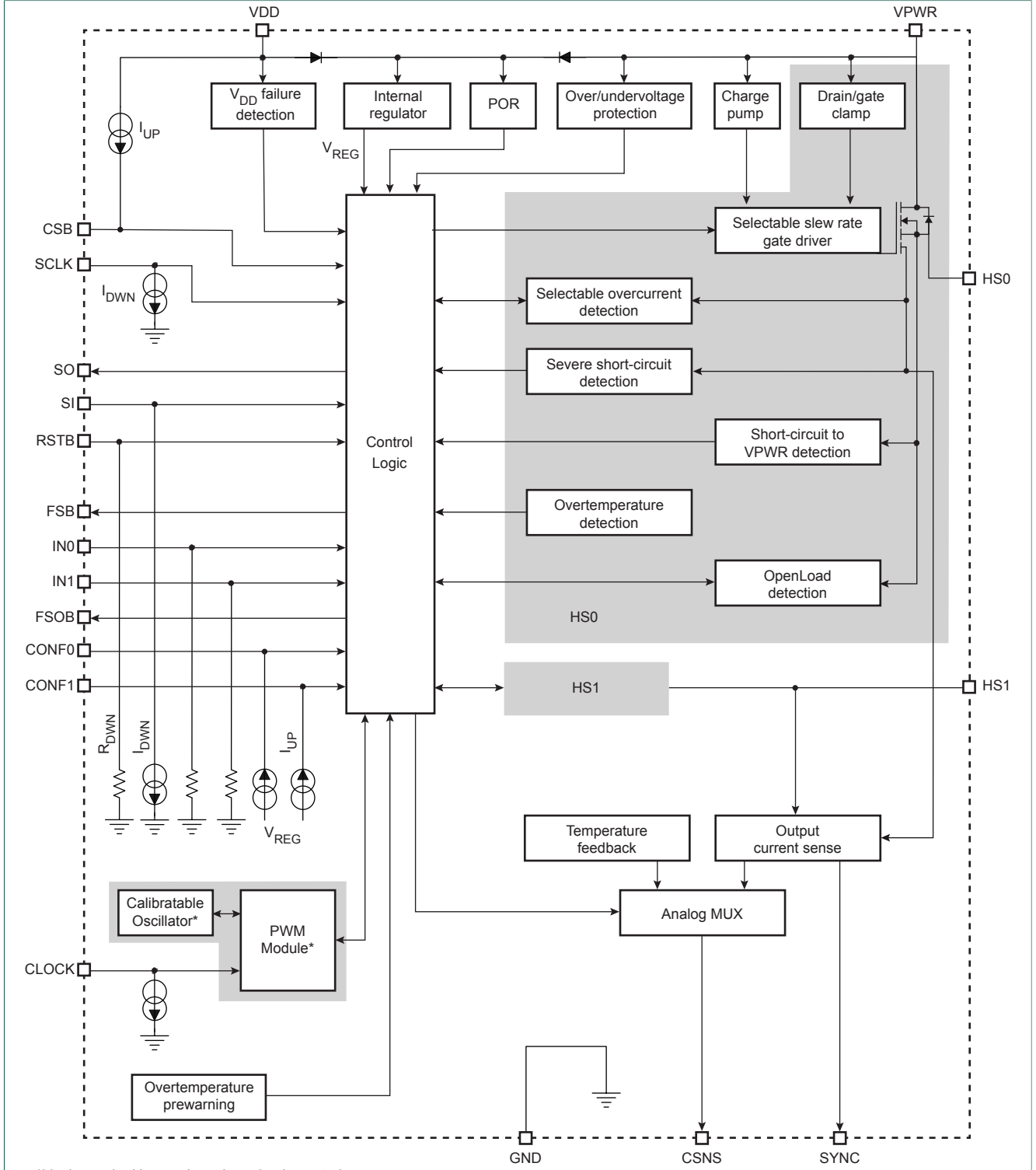

Figure 2. Application diagram

5.6 Internal block diagram



\*blocks marked in grey have been implemented independently for each of both channels

aaa-024245

Figure 3. Internal block diagram

### 5.7 Overcurrent protection management

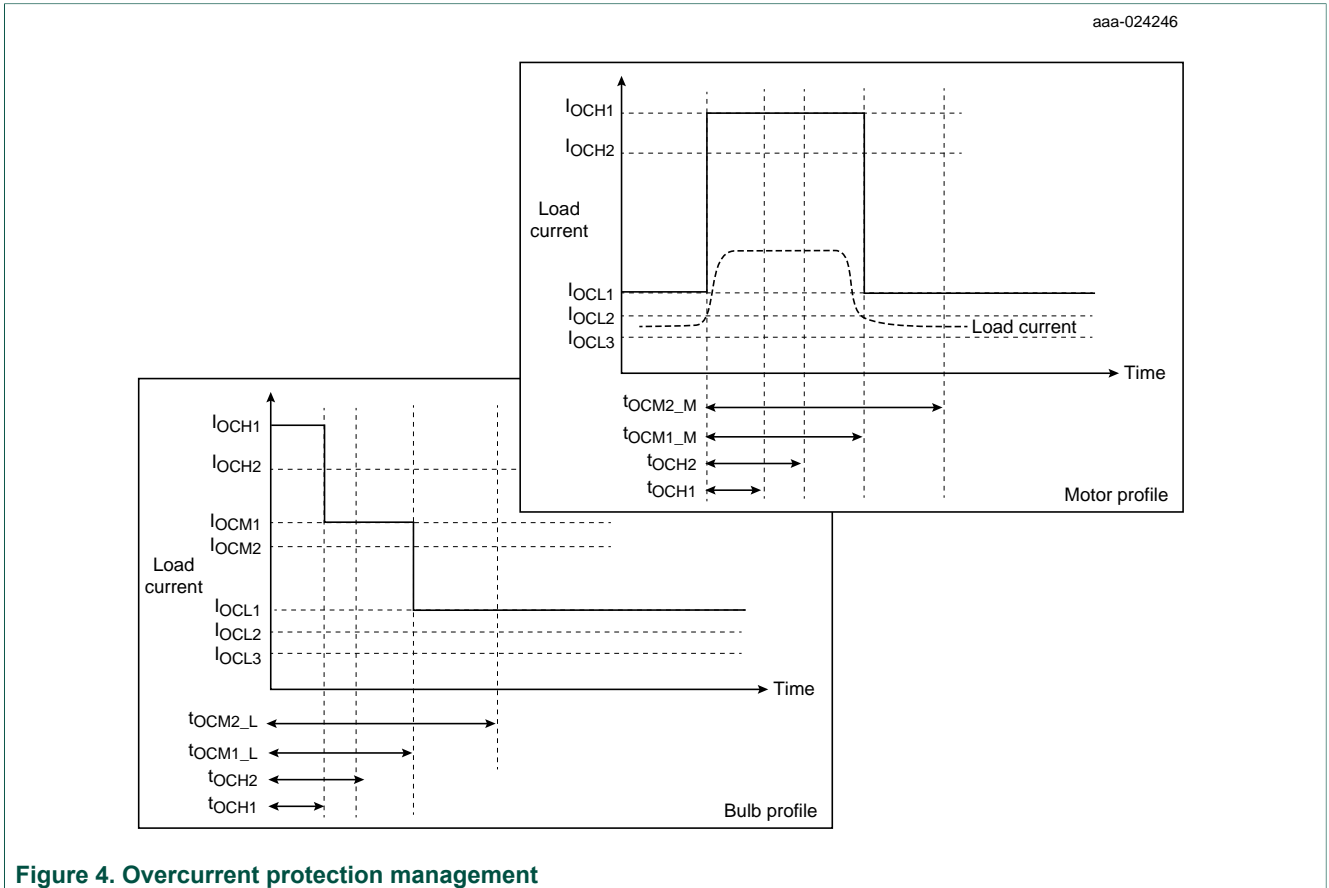

Figure 4. Overcurrent protection management

**5.8 Board description**

Figure 5 and Table 2 show the main elements on the FRDM-MC36XSD-EVB board.

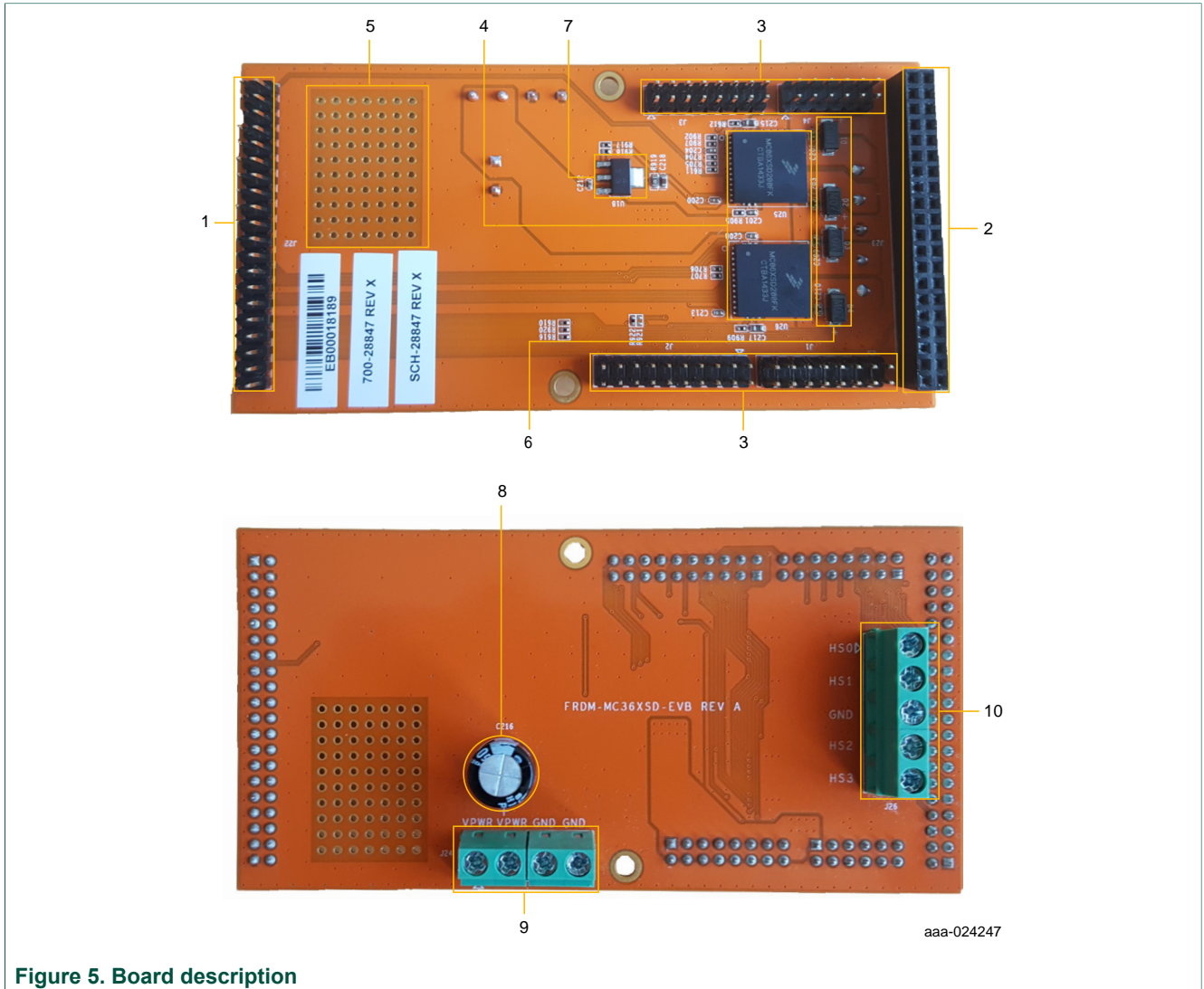

Figure 5. Board description

Table 2. Board description

| Number | Name                   | Description   |
|--------|------------------------|---|
| 1      | RIoTboard connector    | Header male 2x20 pins for RIoTboard (J22)           |
| 2      | Raspberry Pi connector | Header female 2x20 pins for Raspberry Pi (J23)      |
| 3      | Arduino™ connectors    | Male connectors for FRDM-KL25Z or Arduino™ board    |
| 4      | 2 × MC06XSD200         | Dual high-side smart power switches                 |
| 5      | Solder area            | 5x7 holes solder paste area for external components |
| 6      | Power diodes           | Freewheeling diodes for inductive loads             |
| 7      | 3.3 V regulator        | 3.3 V supply for V <sub>DD</sub>                    |
| 8      | 220 μF capacitor       | Supply tank capacitor to support inrush currents    |

| Number | Name               | Description  |
|--------|--------------------|--|
| 9      | Supply connector   | Power connection for $V_{PWR}$ and Ground                      |
| 10     | Outputs connectors | Power connection for Outputs HS0..3 of both devices and Ground |

### 5.8.1 Input signal definitions

The following input signals control the outputs or functions inside the circuit.

**Table 3. Input signal definitions**

| Input name | Description                                       |
|------------|---|
| GPIO0..3   | Logic input to control the output state of HS0..3 |
| MOSI       | Master out slave input for the SPI                |
| CSB        | Chip select bar input for the SPI                 |
| SCLK       | Clock for the SPI                                 |
| RSTB       | Reset of devices. Active low                      |
| CLOCK      | External clock for PWM                            |

### 5.8.2 Output signal definitions

In addition to driving a load, the FRDM-MC36XSD-EVB provides analog output for real time current monitoring and uses the following output signals to reflect the fault and device status.

**Table 4. Output signal definitions**

| Output name | Description  |
|-------------|--|
| FSB         | Open drain active low status flag output to indicate fault |
| FSOB        | Open drain active low fail-safe output                     |
| MISO        | Master in slave out output for the SPI                     |
| CSNS        | Analog monitoring of output current and ICs temperature    |
| SYNC        | Trigger signal for measurements on CSNS pin                |
| HS0..3      | Power outputs of both devices                              |

## 5.9 Screw terminal connections

The board has the following screw terminal connections to connect the power supply and the load.

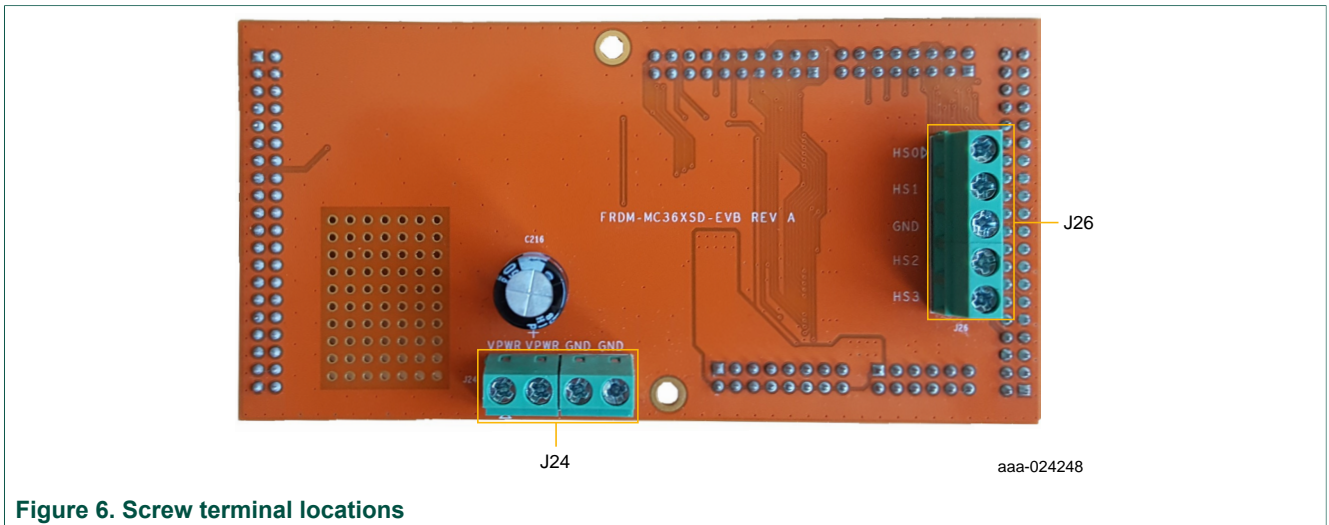

Figure 6. Screw terminal locations

Table 5. Screw terminal connections

| Screw terminal name | Description   |
|---------------------|---|
| J24                 | Power supply connector for the 2 x MC06XSD200   |
| J26                 | Output connector to connect load for both outputs of both devices (HS0...3) to ground |

## 6 Operating with the FRDM-KL25Z and CodeWarrior

NXP’s Freedom development platform is a set of software and hardware tools that provide an ideal platform for the rapid prototyping of microcontroller- based applications. The FRDM-KL25Z board is a key component of the development platform.

The board features a Kinetis L Series microcontroller, the industry’s first microcontroller built on the ARM® Cortex™ –M0+ core. It makes use of the USB, the built in LEDs and the I/O ports available with NXP’s Kinetis KL2x family of microcontrollers. When used in conjunction with other Freedom evaluation boards, the FRDM-KL25Z controls SPI communication between the evaluation board and a PC. It permits the user to regulate the power outputs and implement the features of the device on the evaluation board.

The FRDM-KL25Z also monitors the SPI registers, thereby facilitating the use of safety and advanced diagnostic functions.

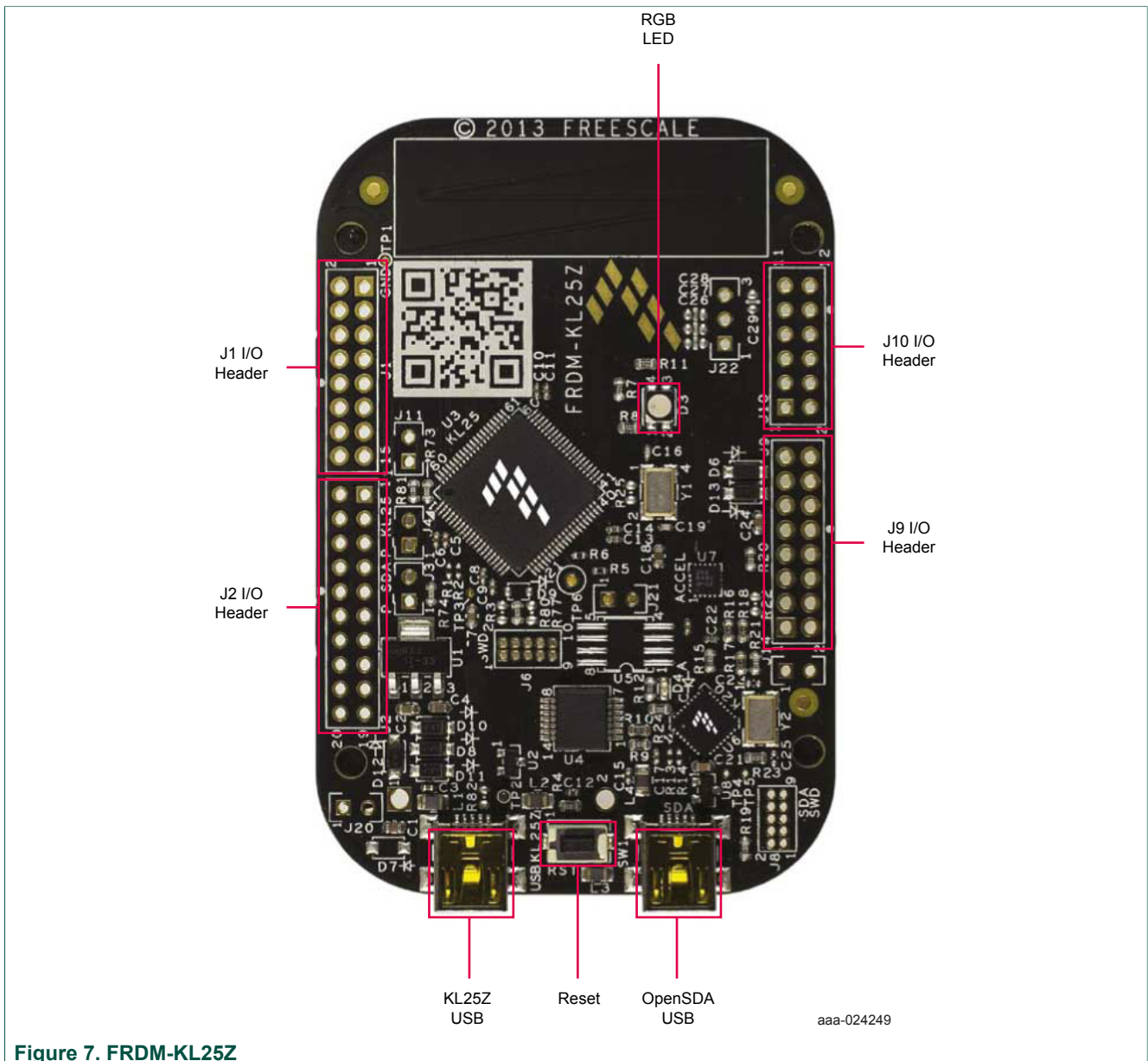
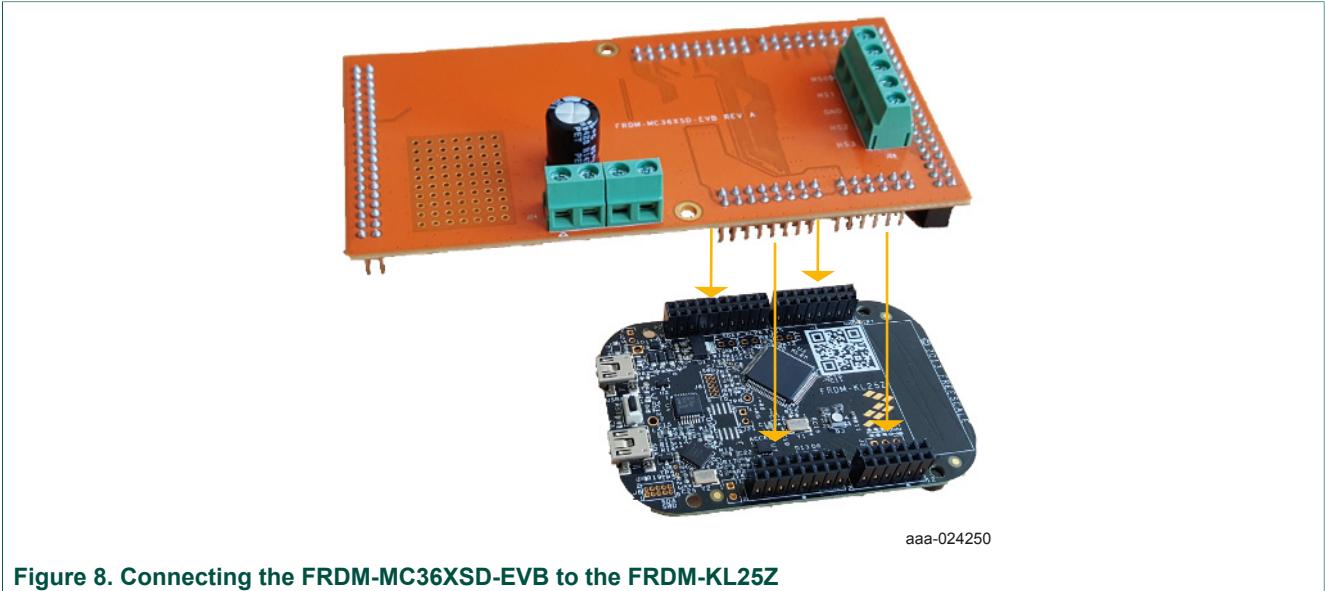

Figure 7. FRDM-KL25Z

### 6.1 Connecting the Freedom KL25Z to the FRDM-MC36XSD-EVB

The FRDM-MC36XSD-EVB connects to the FRDM-KL25Z using the four dual row Arduino™ R3 connectors on the bottom of the board.



**Figure 8. Connecting the FRDM-MC36XSD-EVB to the FRDM-KL25Z**

**Table 6. FRDM-MC36XSD-EVB to FRDM-KL25Z**

| Header | Pin | FRDM-KL25Z hardware name | FRDM-MC36XSD-EVB hardware name | Description                   |
|--------|-----|--------------------------|--------------------------------|-------------------------------|
| J1     | 1   | PTC7                     | N/C                            | No connection                 |
|        | 2   | PTA1                     | N/C                            | No connection                 |
|        | 3   | PTC0                     | N/C                            | No connection                 |
|        | 4   | PTA2                     | N/C                            | No connection                 |
|        | 5   | PTC3                     | N/C                            | No connection                 |
|        | 6   | PTD4                     | GPIO3                          | IN3 signal for HS0            |
|        | 7   | PTC4                     | N/C                            | No connection                 |
|        | 8   | PTA12                    | GPIO2                          | IN2 signal for HS1            |
|        | 9   | PTC5                     | N/C                            | No connection                 |
|        | 10  | PTA4                     | GPIO0                          | IN0 signal for HS3            |
|        | 11  | PTC6                     | N/C                            | No connection                 |
|        | 12  | PTA5                     | GPIO1                          | IN1 signal for HS2            |
|        | 13  | PTC10                    | N/C                            | No connection                 |
|        | 14  | PTC8                     | FSOB_C                         | Fail-safe output              |
|        | 15  | PTC11                    | N/C                            | No connection                 |
|        | 16  | PTC9                     | FSB                            | Fault status to report faults |
| J2     | 1   | PTC12                    | N/C                            | No connection                 |
|        | 2   | PTA13                    | RSTB                           | Reset                         |



| Header | Pin | FRDM-KL25Z hardware name | FRDM-MC36XSD-EVB hardware name | Description                     |
|--------|-----|--------------------------|--------------------------------|---------------------------------|
|        | 3   | PTC13                    | N/C                            | No connection                   |
|        | 4   | PTD5                     | CLOCK                          | Input clock                     |
|        | 5   | PTC16                    | N/C                            | No connection                   |
|        | 6   | PTD0                     | SPI_CS                         | Chip select bar pin             |
|        | 7   | PTC17                    | N/C                            | No connection                   |
|        | 8   | PTD2                     | SPI_MOSI                       | Master Output, Slave Input      |
|        | 9   | PTA16                    | N/C                            | No Connection                   |
|        | 10  | PTD3                     | SPI_MISO                       | Master Input, Slave Output      |
|        | 11  | PTA17                    | N/C                            | No connection                   |
|        | 12  | PTD1                     | SPI_CLK                        | Clock for SPI                   |
|        | 13  | PTE31                    | N/C                            | No connection                   |
|        | 14  | GND                      | GND                            | Gnd                             |
|        | 15  | NC                       | N/C                            | No connection                   |
|        | 16  | VREFH                    | N/C                            | No connection                   |
|        | 17  | PTD6                     | CSNS                           | Current/temp sense reporting    |
|        | 18  | PTE0                     | CSNS                           | Current/temp sense reporting    |
|        | 19  | PTD7                     | N/C                            | No connection                   |
|        | 20  | PTE1                     | SYNC                           | Synchronization signal for CSNS |

## 6.2 Configuring the hardware

The FRDM-MC36XSD-EVB consists of four power high-side channels driven through a parallel and SPI interface. The two devices on board are daisy chained. The board can be configured for use with a FRDM-KL25Z board and the 36VeXtremeSwitch Processor Expert component.

**Note:** When using the FRDM-MC36XSD-EVB, make sure that the maximum supply voltage (VPWR) stays within the 5.0 V to 36 V range. Operating outside this range may cause damage to the board.

To configure the FRDM-MC36XSD-EVB for use with the FRDM-KL25Z and CodeWarrior, do the following:

1. Connect the FRDM-MC36XSD-EVB to the FRDM-KL25Z using the Arduino™ connectors on each board.
2. Connect the USB cable (not supplied with the kit) between the PC and the USB port labeled **SDA** on the FRDM-KL25Z board.
3. With the power switched off, attach the DC power supply to the VBAT and GND screw connector terminal (J24) on the evaluation board.
4. Connect the load to the screw terminal (J26).

[Figure 9](#) illustrates the hardware configuration using a FRDM-KL25Z.

For more details on setup of the FRDM-KL25Z, refer to the FRDM-KL25Z tool summary page at <http://www.nxp.com/FRDM-KL25Z> or the material at <http://www.element14.com/community/docs/DOC-49219>

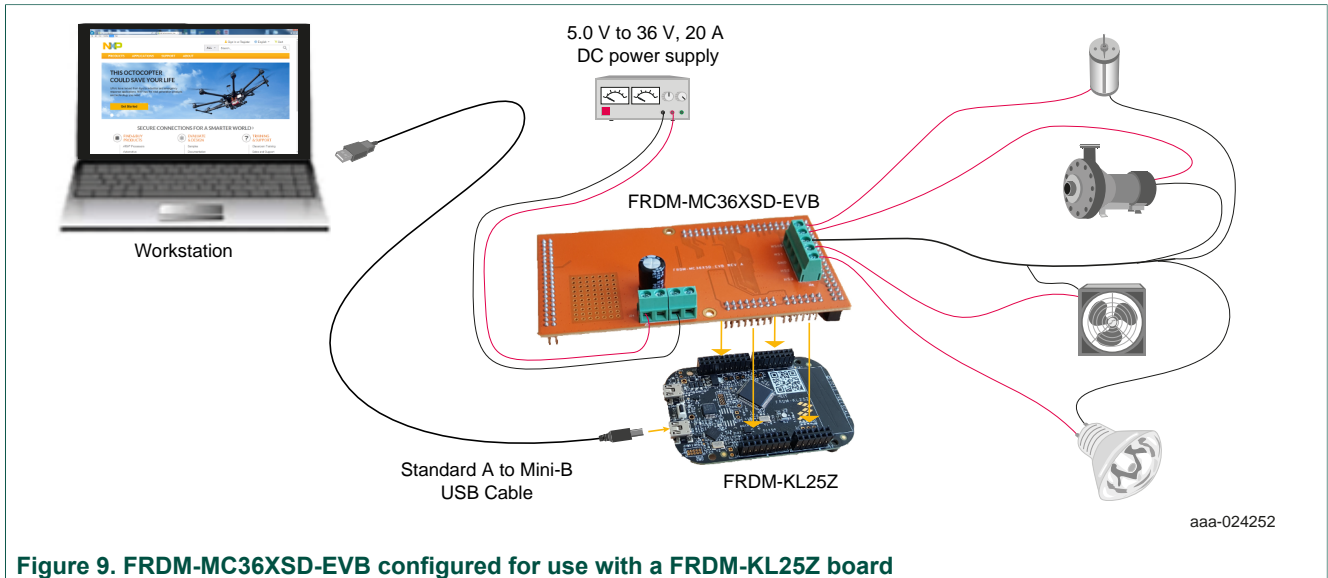

Figure 9. FRDM-MC36XSD-EVB configured for use with a FRDM-KL25Z board

### 6.3 Setting up the software

The software user interface for the FRDM-MC36XSD-EVB board is provided by NXP's CodeWarrior IDE (integrated development environment). A software component—36VeXtremeSwitch—imported into CodeWarrior as part of a project, contains the low-level drivers required to configure the FRDM-MC36XSD-EVB development environment and control the on-board device.

Prior to using the FRDM-MC36XSD-EVB in an evaluation environment, the user must do the following:

1. Download and install CodeWarrior 10.6 or higher onto the PC. To download CodeWarrior, go to the following website: <http://www.nxp.com/CodeWarrior>.
2. Go to the Tool Summary Page at <http://www.nxp.com/FRDM-MC36XSD-EVB> and click on the **Jump Start** icon. Locate and download the zip file named **FRDM-MC36XSDEVB-Demo.zip**. This file contains an example project that incorporates the 36VeXtremeSwitch component. Unzip this file into the computer that has CodeWarrior installed.

For more details on importing a project and configuring CodeWarrior with the 36VeXtremeSwitch component, refer to the [TWR-MC36XSDEVB User Guide](#).

### 6.4 Importing a project example into CodeWarrior

This section describes the high-level flow for importing and using an example project related to the FRDM-MC36XSD-EVB. The example file is included in the zip file downloaded in [Section 6.3 "Setting up the software"](#).

The steps provided below offer only a cursory overview of the process. For more detailed information, see [TWR-MC36XSDEVB User Guide](#).

1. With a Standard A /Mini B USB cable, connect the Standard A plug into the PC and the Mini-B plug into the **SDA** port on the FRDM-KL25Z.
2. Open CodeWarrior on the computer.
3. From the CodeWarrior menu bar, select File>>Import.
4. In the **Select** window, click **Existing Projects into Workspace**, then click **Next**.

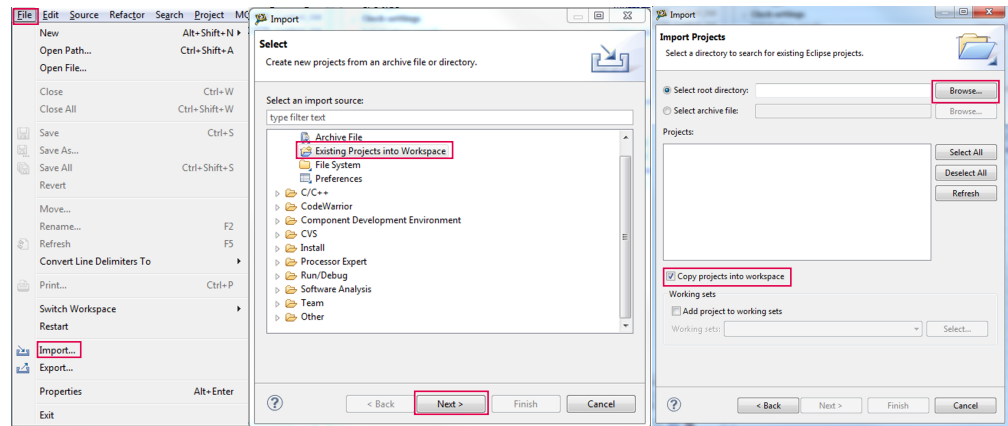

aaa-024253

5. In the **Import Projects** window, assure that the **Select root directory** option is selected. In the corresponding box, select the FRDM-MC36XSDEVB-Demo project downloaded in [Section 6.3 "Setting up the software"](#). Then click **Finish**. With the demo project open in CodeWarrior, do the following:
  - a. In the CodeWarrior Components panel, click on the **Generate Processor Expert** code icon.
  - b. In the CodeWarrior menu bar, click on the **Build** icon.
  - c. From the **Debug** menu, click **Debug Configurations**. Locate and select the file FRDM-MC36XSDEVB-Demo\_FLASH\_OpenSDA. Then click the **Debug** button.

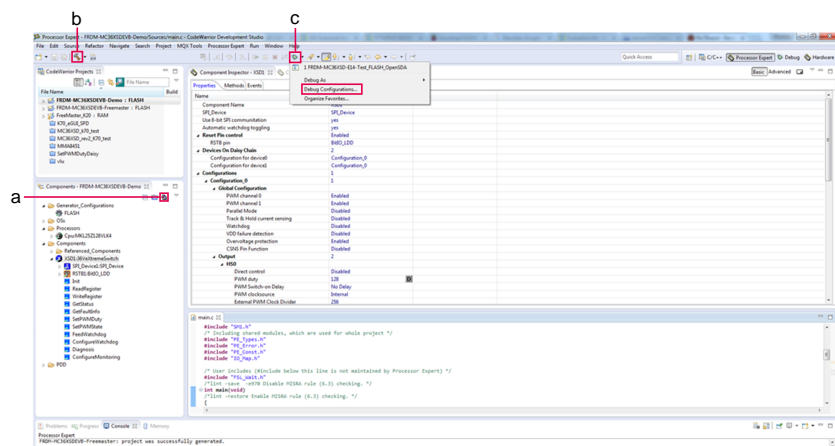

aaa-024254

This example project toggles the different outputs at 1 Hz frequency. The user can modify main.c to customize the code, use some of the functions listed under the XSD1:36VeXtremeSwitch component or configure the different properties set during initialization.

## 7 Operating with Raspberry Pi and Python

The Raspberry Pi is a multifunctional board designed as an educational tool. It features a Broadcom BCM2836 SoC (quad-core ARM Cortex-A7), VideoCore IV GPU, and 1 GB of RAM (Model B). It also includes four USB ports, an HDMI port, and a 10/100 Ethernet controller.



Figure 10. Raspberry Pi board

The Raspberry Pi has an easy access 40-pin GPIO I/O header (2x20, 0.1" Center).

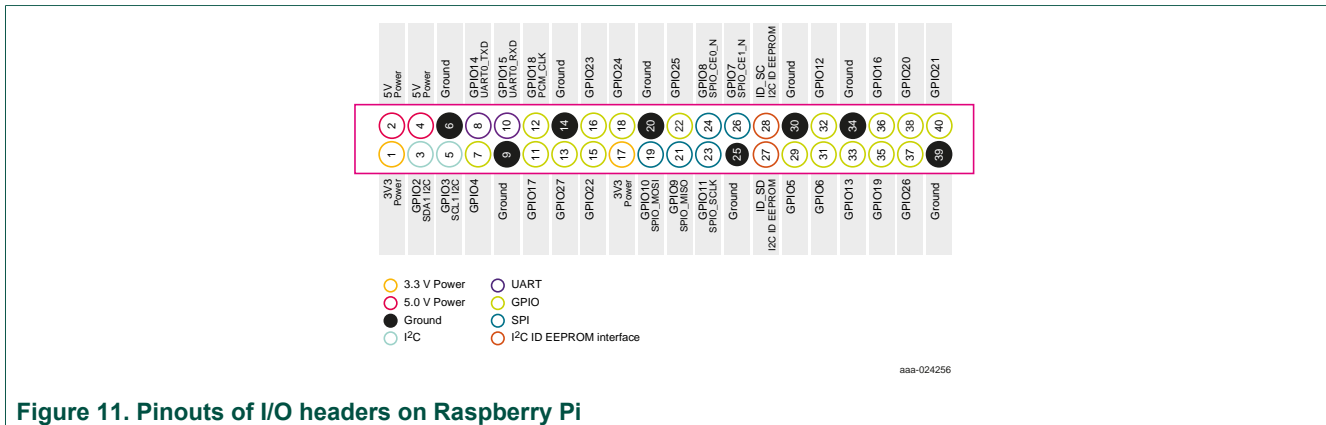
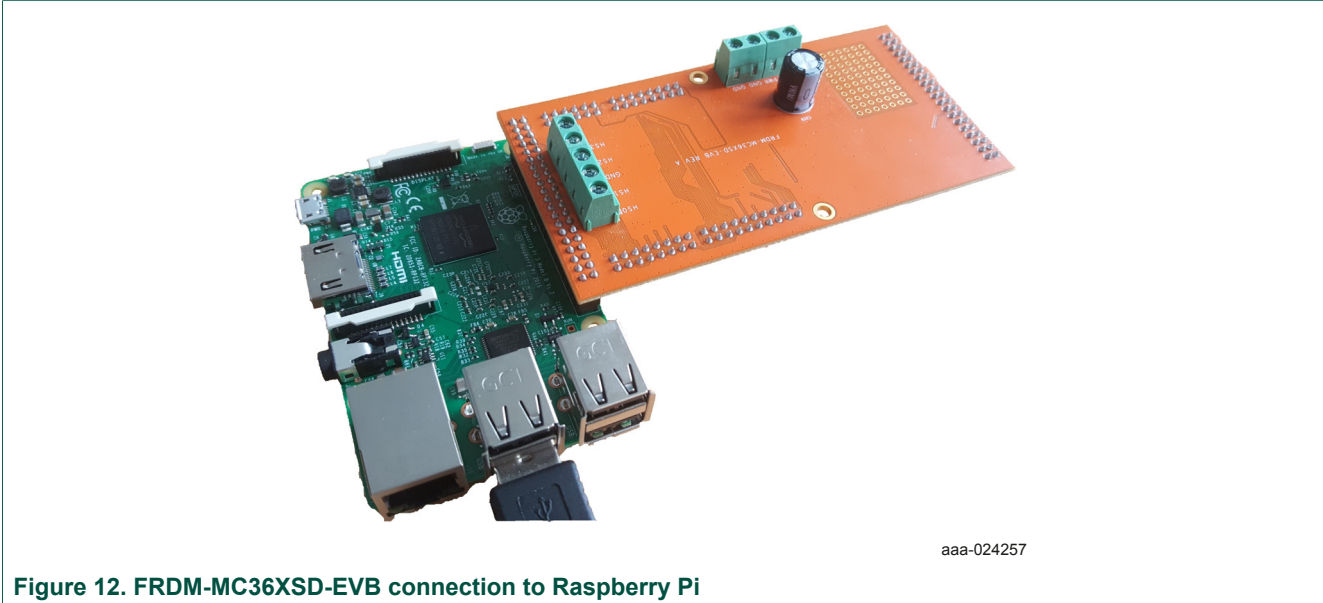

Figure 11. Pinouts of I/O headers on Raspberry Pi

### 7.1 Connecting Raspberry Pi to the FRDM-MC36XSD-EVB

To connect the FRDM-MC36XSD-EVB, align the connector J8 on the evaluation board with the GPIO pins on Raspberry Pi. Then mount the evaluation board to the Raspberry Pi board.



aaa-024257

Figure 12. FRDM-MC36XSD-EVB connection to Raspberry Pi

Table 7. Connecting the Raspberry Pi to the board

| Raspberry Pi |     |               | FRDM-MC36XSD-EVB |     |               | Description                     |
|--------------|-----|---------------|------------------|-----|---------------|---------------------------------|
| Header       | Pin | Hardware name | Header           | Pin | Hardware name |                                 |
| J8           | 1   | 3V3           | J23              | 1   | —             | No connection                   |
|              | 2   | 5V            |                  | 2   | —             | No connection                   |
|              | 3   | GPIO2         |                  | 3   | —             | No connection                   |
|              | 4   | 5V            |                  | 4   | —             | No connection                   |
|              | 5   | GPIO3         |                  | 5   | —             | No connection                   |
|              | 6   | GND           |                  | 6   | GND           | Gnd                             |
|              | 7   | GPIO4         |                  | 7   | —             | No connection                   |
|              | 8   | GPIO14        |                  | 8   | GPIO3         | IN3 signal for HS0              |
|              | 9   | GND           |                  | 9   | GND           | Gnd                             |
|              | 10  | GPIO15        |                  | 10  | GPIO2         | IN2 signal for HS1              |
|              | 11  | GPIO17        |                  | 11  | RSTB          | Reset                           |
|              | 12  | GPIO18        |                  | 12  | GPIO0         | IN0 signal for HS3              |
|              | 13  | GPIO27        |                  | 13  | SYNC          | Synchronization signal for CSNS |
|              | 14  | GND           |                  | 14  | GND           | Fail-safe output                |
|              | 15  | GPIO22        |                  | 15  | —             | No connection                   |
|              | 16  | GPIO23        |                  | 16  | GPIO1         | IN1 signal for HS2              |
|              | 17  | 3V3           |                  | 17  | —             | No connection                   |
|              | 18  | GPIO24        |                  | 18  | FSOB_C        | Fail-safe output                |
|              | 19  | GPIO10        |                  | J23 | 19            | SPI_MOSI                        |
|              | 20  | GND           | 20               |     | GND           | Gnd                             |

| Raspberry Pi |     |               | FRDM-MC36XSD-EVB |     |               | Description                   |
|--------------|-----|---------------|------------------|-----|---------------|-------------------------------|
| Header       | Pin | Hardware name | Header           | Pin | Hardware name |                               |
|              | 21  | GPIO9         |                  | 21  | SPI_MISO      | Master Input, Slave Output    |
|              | 22  | GPIO25        |                  | 22  | FSB           | Fault status to report faults |
|              | 23  | GPIO11        |                  | 23  | SPI_CLK       | Clock for SPI                 |
|              | 24  | GPIO8         |                  | 24  | SPI_CS        | Chip select bar pin           |
|              | 25  | GND           |                  | 25  | GND           | Gnd                           |
|              | 26  | GPIO7         |                  | 26  | —             | No connection                 |
|              | 27  | ID_SD         |                  | 27  | —             | No connection                 |
|              | 28  | ID_SC         |                  | 28  | —             | No connection                 |
|              | 29  | GPIO5         |                  | 29  | —             | No connection                 |
|              | 30  | GND           |                  | 30  | GND           | Gnd                           |
|              | 31  | GPIO6         |                  | 31  | —             | No connection                 |
|              | 32  | GPIO12        |                  | 32  | CLOCK         | Input clock                   |
|              | 33  | GPIO13        |                  | 33  | —             | No connection                 |
|              | 34  | GND           |                  | 34  | GND           | Gnd                           |
|              | 35  | GPIO19        |                  | 35  | —             | No connection                 |
|              | 36  | GPIO16        |                  | 36  | —             | No connection                 |
|              | 37  | GPIO26        |                  | 37  | —             | No connection                 |
|              | 38  | GPIO20        |                  | 38  | —             | No connection                 |
|              | 39  | GND           |                  | 39  | GND           | No connection                 |
|              | 40  | GPIO21        |                  | 40  | —             | No connection                 |

## 7.2 Configuring the hardware with Raspberry Pi

With the FRDM-MC36XSD-EVB mounted to the Raspberry Pi board as described in [Section 7.1 "Connecting Raspberry Pi to the FRDM-MC36XSD-EVB"](#), make the following connections:

On the FRDM-MC36XSD-EVB:

1. Connect 5.0 V to 36 V DC power supply to connector J24.
2. Connect up to four loads to connector J26.

On the Raspberry Pi board:

1. Connect an HDMI-compatible monitor to the HDMI port.
2. Connect the USB mouse and keyboard to one of the USB connectors.
3. Connect a 5.0 V 2.0 A power supply to the Micro-USB Power port.

[Figure 13](#) illustrates the hardware configuration with the Raspberry Pi board.

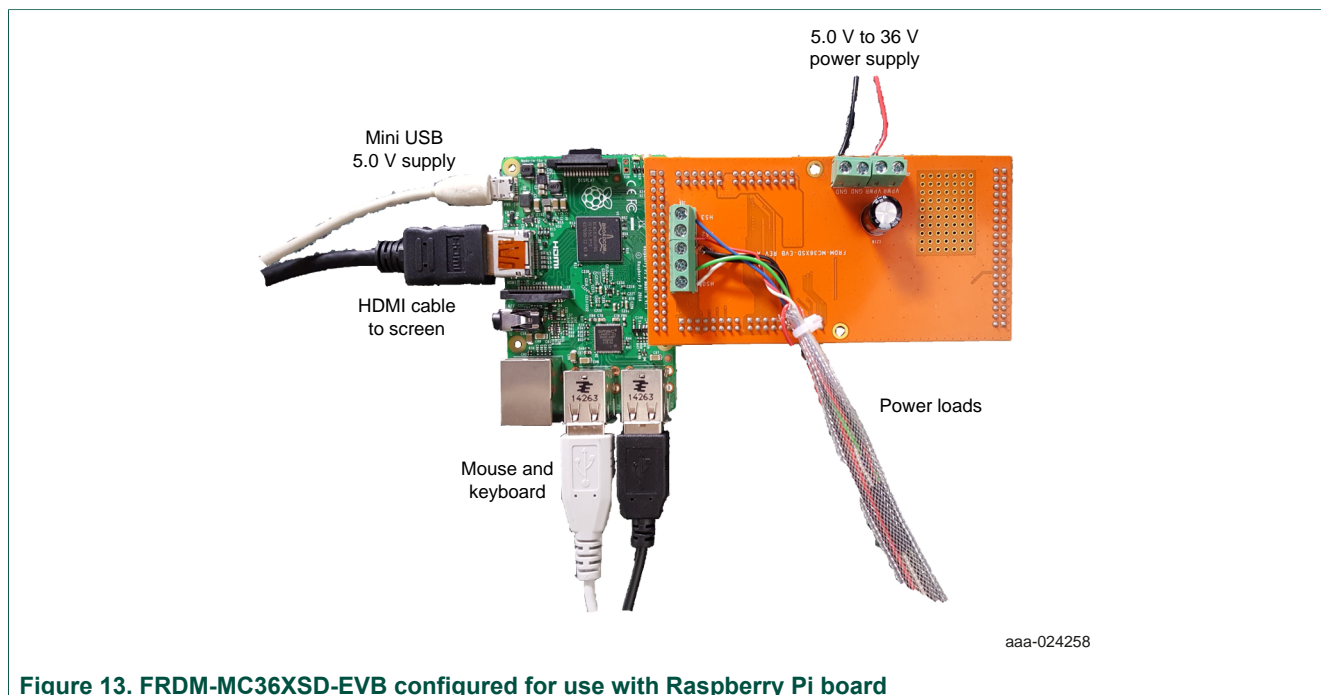

### 7.3 Setting up the Raspberry Pi software

The procedure for setting up the software that supports using the FRDM-MC36XSD-EVB with a Raspberry Pi 2 Model B board is as follows:

1. Got to the Tool Summary Page at <http://www.nxp.com/FRDM-MC36XSD-EVB> and click on the **Jump Start** icon. Locate and download the zip file named **Rpi\_save\_HSSwitch\_20160121.zip**. This file contains a microcode image of the Raspbian operating system and a Python demo file that illustrates the functionality of the FRDM-MC36XSD-EVB with Raspberry Pi.
2. Unzip the file. The resulting image file appears with the name **Rpi\_save\_HSSwitch\_20160121.img**.
3. Flash the image to an 8 GB SD card. To flash the image, follow the instructions at: <https://www.raspberrypi.org/documentation/installation/installing-images/>
4. Insert the SD card into the Raspberry Pi SD slot (located on the back of the board). Power up the board by inserting a powered USB cable into the Micro USB port on the Raspberry Pi.
5. If a login is required, use: Username = **Pi** Password = **raspberry**.

Open a terminal window and enter the following command to run the Python code: **sudo python Highside\_switch.py**

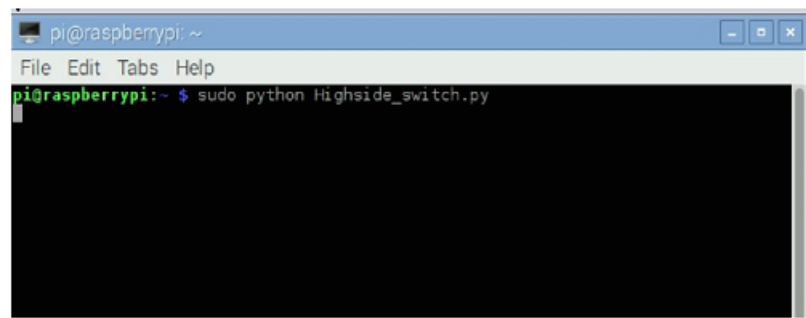

aaa-024259

Figure 14. Raspberry Pi Terminal and launch command

A turn On/Off demo sequence on the different outputs HS0..3 is launched.

The Python code is located at /home/Pi/Highside\_switch.py and can be edited to accommodate the user's requirements.

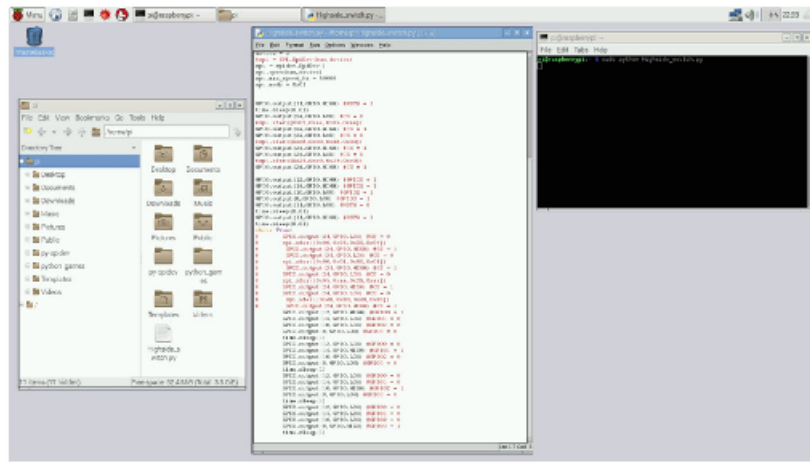

aaa-024260

Figure 15. Raspberry Pi dashboard



## 8 Operating with the RIoTboard

The RIoTboard is based on the i.MX 6Solo processor from NXP and integrates all the functionality of this multimedia application processor. The board supports a wide range of internet devices, such as game consoles and navigation devices. It offers a variety of I/O options, including four Standard A USB ports, one Mini USB port, an Ethernet port and a 40-pin GPIO expansion port. For more details on RIoTBoard, go to <https://www.element14.com/community/docs/DOC-74480/riot-board-starter-kit>

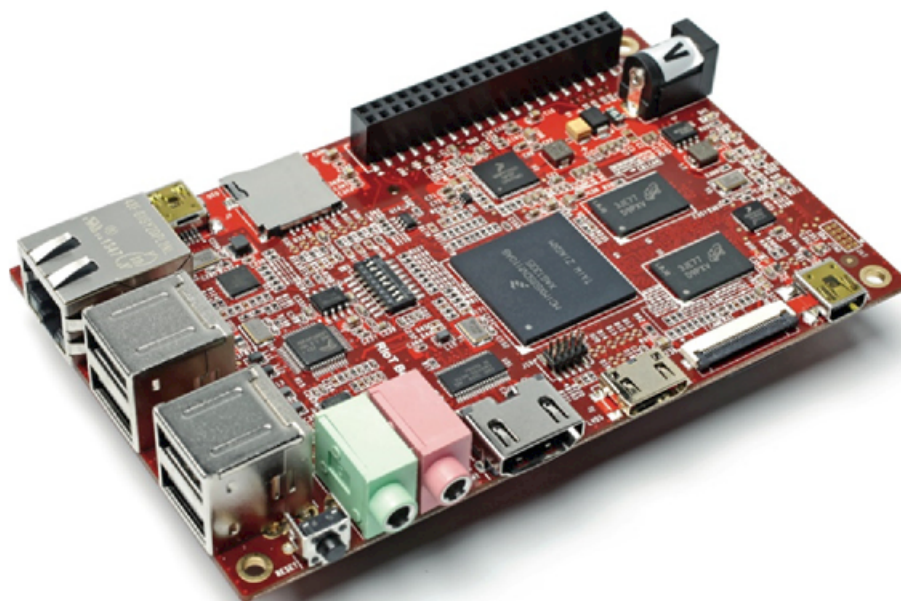

aaa-024261

Figure 16. RIoTboard

### 8.1 Connecting RIoTboard to the FRDM-MC36XSD-EVB

To connect the FRDM-MC36XSD-EVB to a RIoTboard, mount the GPIO header (J13) on the FRDM-MC36XSD-EVB to the RIoTboard.

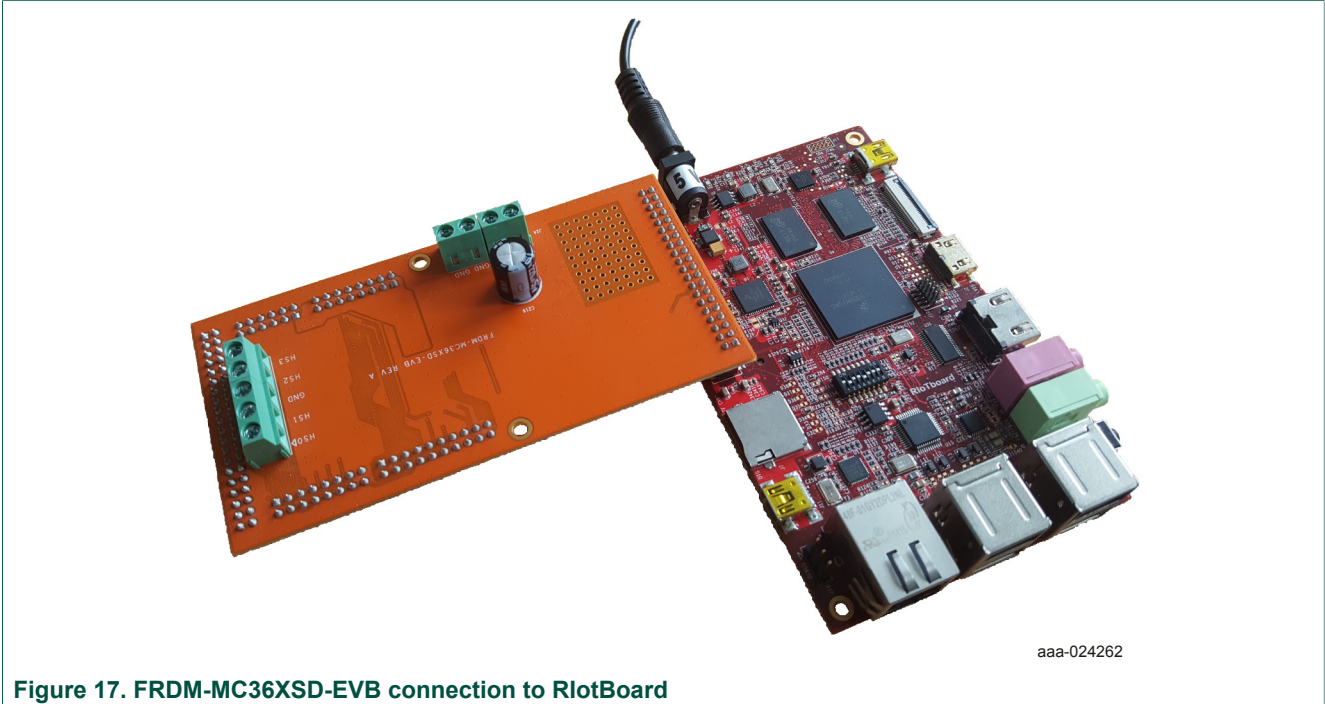

aaa-024262

Figure 17. FRDM-MC36XSD-EVB connection to RloTBoard

Table 8. FRDM-MC36XSD-EVB to RloTboard connections

| RloTboard |     |               | FRDM-MC36XSD-EVB |     |               | Description                     |
|-----------|-----|---------------|------------------|-----|---------------|---------------------------------|
| Header    | Pin | Hardware name | Header           | Pin | Hardware name |                                 |
| J13       | 1   | VDD_NVCC      | J22              | 1   | —             | No connection                   |
|           | 2   | 5VIN          |                  | 2   | —             | No connection                   |
|           | 3   | GND           |                  | 3   | Gnd           | Gnd                             |
|           | 4   | GND           |                  | 4   | Gnd           | Gnd                             |
|           | 5   | GPIO4_16      |                  | 5   | GPIO0         | IN0 signal for HS3              |
|           | 6   | CSPI3_CLK     |                  | 6   | SPI_CLK       | Clock for SPI                   |
|           | 7   | GPIO4_17      |                  | 7   | GPIO1         | IN1 signal for HS2              |
|           | 8   | CSPI3_MOSI    |                  | 8   | SPI_MOSI      | Master Output, Slave Input      |
|           | 9   | GPIO4_18      |                  | 9   | FSOB_C        | Fail-safe output                |
|           | 10  | CSPI3_MISO    |                  | 10  | SPI_MISO      | Master Input, Slave Output      |
|           | 11  | GPIO4_19      |                  | 11  | FSB           | Fault status to report faults   |
|           | 12  | CSPI3_CS0     |                  | 12  | SPI_CS        | Chip select bar pin             |
|           | 13  | CSPI3_CS1     |                  | 13  | GPIO2         | IN2 signal for HS1              |
|           | 14  | CSPI2_CS1     |                  | 14  | GPIO3         | IN3 signal for HS0              |
|           | 15  | GPIO4_31      |                  | 15  | RSTB          | Reset                           |
|           | 16  | CSPI2_MOSI    |                  | 16  | SYNC          | Synchronization signal for CSNS |
|           | 17  | GPIO5_05      |                  | 17  | —             | No connection                   |
|           | 18  | CSPI2_MISO    |                  | 18  | —             | No connection                   |

| RloTboard |     |               | FRDM-MC36XSD-EVB |     |               | Description   |
|-----------|-----|---------------|------------------|-----|---------------|---------------|
| Header    | Pin | Hardware name | Header           | Pin | Hardware name |               |
|           | 19  | GPIO5_06      |                  | 19  | —             | No connection |
|           | 20  | CSPI2_CS0     |                  | 20  | —             | No connection |
|           | 21  | GPIO5_07      |                  | 21  | —             | No connection |
|           | 22  | CSPI2_CLK     |                  | 22  | —             | No connection |
|           | 23  | GPIO5_08      |                  | 23  | —             | No connection |
|           | 24  | UART3_RXD     |                  | 24  | —             | No connection |
|           | 25  | GPIO4_26      |                  | 25  | —             | No connection |
|           | 26  | UART3_TXD     |                  | 26  | —             | No connection |
|           | 27  | GPIO4_27      |                  | 27  | —             | No connection |
|           | 28  | UART4_RXD     |                  | 28  | —             | No connection |
|           | 29  | CSPI3_RDY     |                  | 29  | —             | No connection |
|           | 30  | UART4_TXD     |                  | 30  | —             | No connection |
|           | 31  | I2C3_SCL      |                  | 31  | —             | No connection |
|           | 32  | UART5_RXD     |                  | 32  | —             | No connection |
|           | 33  | I2C3_SDA      |                  | 33  | —             | No connection |
|           | 34  | UART5_TXD     |                  | 34  | —             | No connection |
|           | 35  | I2C4_SCL      |                  | 35  | —             | No connection |
|           | 36  | PWM1          |                  | 36  | —             | No connection |
|           | 37  | I2C4_SDA      |                  | 37  | —             | No connection |
|           | 38  | PWM2          |                  | 38  | —             | No connection |
|           | 39  | GND           |                  | 39  | Gnd           | Gnd           |
|           | 40  | PWM3          |                  | 40  | CLOCK         | Input clock   |

## 8.2 Setting up the RloTboard software

The procedure for setting up the software that supports using the FRDM-MC36XSD-EVB with a RloTboard is as follows:

1. Go to the Tool Summary Page at <http://www.nxp.com/FRDM-MC36XSD-EVB> and click on the **Jump Start** icon. Locate and download the zip file named **tools\_SVN2487(2016-1-22).zip**. Unzip the file to a location on the host PC.
2. Connect a 5.0 V DC power supply to the RloTboard.
3. Connect one end of a Mini USB cable to the USB OTG interface on the RloTboard. Connect the other end of the cable to the host PC.
4. Power down the board and set the boot switch (SW1) on the RloTboard to serial download mode, as shown below:

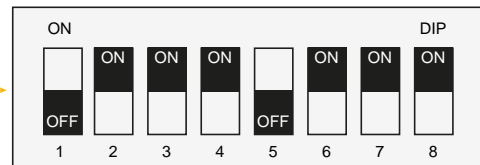
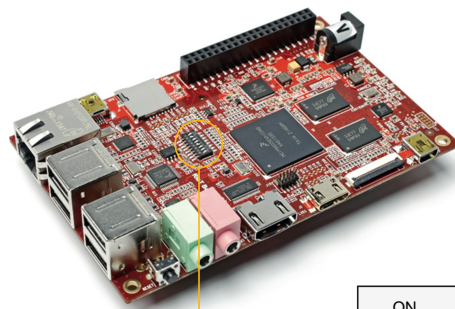

aaa-024263

- Click on the tools\_SVN2487(2016-1-22) folder (extracted in Step 1) and open the folder **Mfgtools-Rel-4.1.0\_130816\_MX6DL\_UPDATER**. Locate and activate **MfgTools2.exe**, then power up the RIoTboard.
- Click **Start** in the following window; when download process is done, click **Stop** to finish.

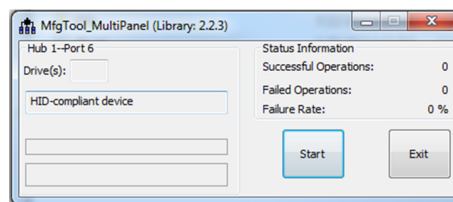

aaa-024264

- Power off the RIoTboard and set the boot switches (SW1) to eMMC boot mode, as shown below:

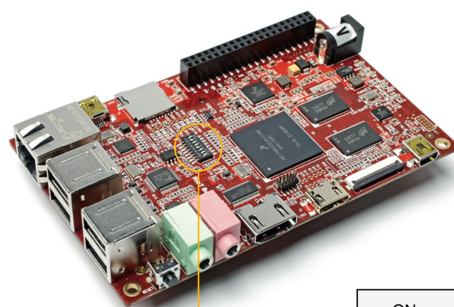

aaa-024265

8. Boot the RlotBoard and open a terminal window. Enter the following command:  
root@linaro-ubuntu-desktop:~# **python source/Highside\_switch.py driver\_test**

The results and driven output appear as follows :

```
Init gpio for Highside switch
Set gpio direction
RSTB = 1
GPIO0 = 1
Init Highside Switch driver
GPIO1 = 1
GPIO2 = 1
GPIO3 = 1
GPIO0 = 0
GPIO1 = 1
GPIO2 = 1
GPIO3 = 1
GPIO0 = 1
GPIO1 = 0
GPIO2 = 1
GPIO3 = 1
```

The file **Highside\_switch.py** can be edited for specific usage.

## 9 Schematics, board layout and bill of materials

FRDM-MC36XSD-EVB board schematics, board layout and bill of materials are available in the download tab of the FRDM-MC36XSD-EVB Tool summary page at the following URL: [www.nxp.com/FRDM-MC36XSD-EVB](http://www.nxp.com/FRDM-MC36XSD-EVB)

## 10 References

The following are URLs related to NXP products and application solutions:

| NXP.com support pages | Description          | URL  |
|-----------------------|----------------------|--|
| FRDM-MC36XSD-EVB      | Tool summary page    | <a href="http://www.nxp.com/FRDM-MC36XSD-EVB">www.nxp.com/FRDM-MC36XSD-EVB</a> |
| FRDM-KL25Z            | Tool summary page    | <a href="http://www.nxp.com/FRDM-KL25Z">www.nxp.com/FRDM-KL25Z</a>             |
| MC06XSD200            | Product summary page | <a href="http://www.nxp.com/MC36XSD">http://www.nxp.com/MC36XSD</a>            |

## 11 Contact information

Visit <http://www.nxp.com/support> for a list of phone numbers within your region.

Visit <http://www.nxp.com/warranty> to submit a request for tool warranty.

## 12 Revision history

| Revision | Date   | Description of changes |
|----------|--------|------------------------|
| 1.0      | 8/2016 | Initial release        |

## 13 Legal information

### 13.1 Definitions

**Draft** — The document is a draft version only. The content is still under internal review and subject to formal approval, which may result in modifications or additions. NXP Semiconductors does not give any representations or warranties as to the accuracy or completeness of information included herein and shall have no liability for the consequences of use of such information.

### 13.2 Disclaimers

Information in this document is provided solely to enable system and software implementers to use NXP products. There are no express or implied copyright licenses granted hereunder to design or fabricate any integrated circuits based on the information in this document. NXP reserves the right to make changes without further notice to any products herein.

NXP makes no warranty, representation, or guarantee regarding the suitability of its products for any particular purpose, nor does NXP assume any liability arising out of the application or use of any product or circuit, and specifically disclaims any and all liability, including without limitation

consequential or incidental damages. "Typical" parameters that may be provided in NXP data sheets and/or specifications can and do vary in different applications, and actual performance may vary over time. All operating parameters, including "typicals," must be validated for each customer application by customer's technical experts. NXP does not convey any license under its patent rights nor the rights of others. NXP sells products pursuant to standard terms and conditions of sale, which can be found at the following address: [nxp.com/salestermsandconditions](http://nxp.com/salestermsandconditions).

### 13.3 Trademarks

Notice: All referenced brands, product names, service names and trademarks are the property of their respective owners.

**NXP** — is a trademark of NXP B.V.

**the NXP logo** — is a trademark of NXP B.V.

**Freescale** — is a trademark of NXP B.V.

**the Freescale logo** — is a trademark of NXP B.V.

**CodeWarrior** — is a trademark of NXP B.V.

**SMARTMOS** — is a trademark of NXP B.V.

## Tables

---

|         |                                  |    |                   |  |    |
|---------|----------------------------------|----|-------------------|--|----|
| Tab. 1. | Device features .....            | 8  | Tab. 6.           | FRDM-MC36XSD-EVB to FRDM-KL25Z .....           | 16 |
| Tab. 2. | Board description .....          | 12 | Tab. 7.           | Connecting the Raspberry Pi to the board ..... | 21 |
| Tab. 3. | Input signal definitions .....   | 13 | Tab. 8.           | FRDM-MC36XSD-EVB to RIoTboard                  |    |
| Tab. 4. | Output signal definitions .....  | 13 | connections ..... | 26   |    |
| Tab. 5. | Screw terminal connections ..... | 14 |                   |  |    |



## Figures

|          |  |    |          |  |    |
|----------|--|----|----------|--|----|
| Fig. 1.  | Block diagram .....  | 7  | Fig. 11. | Pinouts of I/O headers on Raspberry Pi .....                         | 20 |
| Fig. 2.  | Application diagram .....  | 9  | Fig. 12. | FRDM-MC36XSD-EVB connection to<br>Raspberry Pi .....                 | 21 |
| Fig. 3.  | Internal block diagram .....   | 10 | Fig. 13. | FRDM-MC36XSD-EVB configured for use<br>with Raspberry Pi board ..... | 23 |
| Fig. 4.  | Overcurrent protection management .....                              | 11 | Fig. 14. | Raspberry Pi Terminal and launch<br>command .....                    | 24 |
| Fig. 5.  | Board description .....  | 12 | Fig. 15. | Raspberry Pi dashboard .....   | 24 |
| Fig. 6.  | Screw terminal locations .....                                       | 14 | Fig. 16. | RIoTboard .....  | 25 |
| Fig. 7.  | FRDM-KL25Z .....   | 15 | Fig. 17. | FRDM-MC36XSD-EVB connection to<br>RIoTBoard .....                    | 26 |
| Fig. 8.  | Connecting the FRDM-MC36XSD-EVB to<br>the FRDM-KL25Z .....           | 16 |          |  |    |
| Fig. 9.  | FRDM-MC36XSD-EVB configured for use<br>with a FRDM-KL25Z board ..... | 18 |          |  |    |
| Fig. 10. | Raspberry Pi board .....   | 20 |          |  |    |

**Contents**

**1 FRDM-MC36XSD-EVB ..... 1**

**2 Important notice .....2**

**3 Overview of the FRDM-MC36XSD-EVB development environment ..... 3**

**4 Getting started ..... 4**

4.1 Kit contents/packing list .....4

4.2 Jump start .....4

4.3 Required equipment ..... 4

4.4 System requirements .....5

**5 Getting to know the hardware ..... 6**

5.1 Board overview .....6

5.2 Board features .....6

5.3 Block diagram .....7

5.4 Device features .....7

5.5 Application diagram .....9

5.6 Internal block diagram ..... 10

5.7 Overcurrent protection management ..... 11

5.8 Board description .....12

5.8.1 Input signal definitions .....13

5.8.2 Output signal definitions .....13

5.9 Screw terminal connections .....13

**6 Operating with the FRDM-KL25Z and CodeWarrior .....15**

6.1 Connecting the Freedom KL25Z to the FRDM-MC36XSD-EVB ..... 16

6.2 Configuring the hardware ..... 17

6.3 Setting up the software .....18

6.4 Importing a project example into CodeWarrior .....18

**7 Operating with Raspberry Pi and Python .....20**

7.1 Connecting Raspberry Pi to the FRDM-MC36XSD-EVB .....20

7.2 Configuring the hardware with Raspberry Pi .....22

7.3 Setting up the Raspberry Pi software ..... 23

**8 Operating with the RIoTboard .....25**

8.1 Connecting RIoTboard to the FRDM-MC36XSD-EVB .....25

8.2 Setting up the RIoTboard software .....27

**9 Schematics, board layout and bill of materials .....30**

**10 References ..... 30**

**11 Contact information ..... 30**

**12 Revision history ..... 30**

**13 Legal information ..... 31**