



32-bit Automotive Microcontrollers

MAC7112

建议不要在新设计中使用该软件
建议不要在新设计中使用本页介绍的产品。

Last Updated: Apr 9, 2022

The MAC7112 is a member of a pin-compatible family of 32-bit Flash memory-based devices developed specifically for embedded automotive applications. It addresses the growing demand for cost-effective 32-bit performance enhancements as traditional body, chassis and safety application exceed the performance scope of many 16-bit offerings.

MAC7100 Family r2 Block Diagram Block Diagram

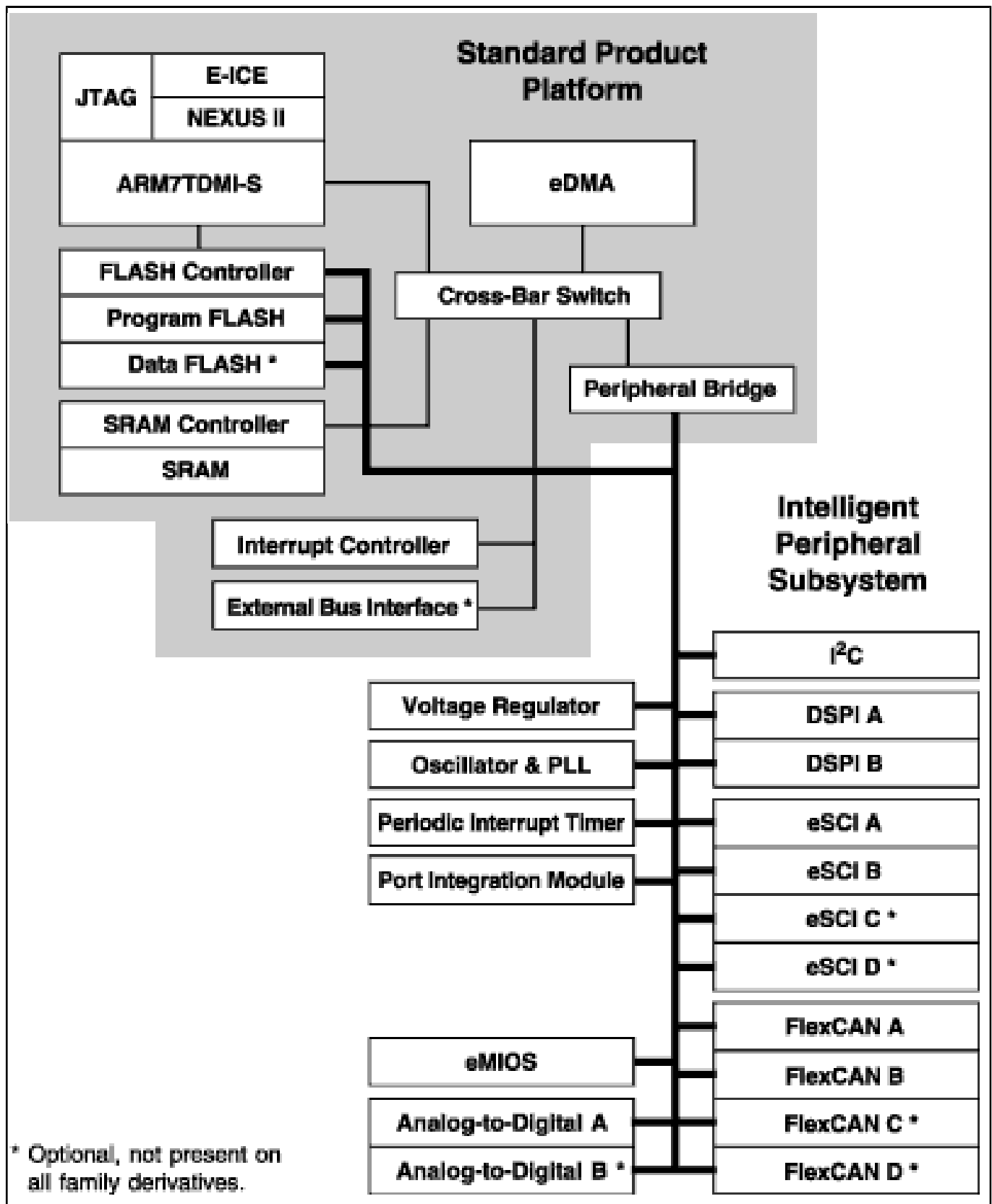

Note: The information on this document is subject to change without notice.

www.nxp.com

NXP and the NXP logo are trademarks of NXP B.V. All other product or service names are the property of their respective owners. The related technology may be protected by any or all of patents, copyrights, designs and trade secrets. All rights reserved. © 2024 NXP B.V.